



Range of centrifugal roof mounted fans to mount directly above a circular duct for the ventilation of housing and small enclosure.

#### Description

- Centrifugal roof mounted fan in horizontal discharge format.
- Very low profile design.
- ON-OFF electrical isolated switched.
- Models suitable for operation within ambient air temperatures between -20°C up to +40°C
- Fan speed adjustable with the potentiometer placed in the connection box or with an external control type REB ECOWATT.
- Analogical input with terminals in the connection box to control the fan with 0-10V input signal.

#### Motors

Brushless EC high-efficient and low consumption motor, with external rotor, IP44.

Motor with thermal protection and on-off switch IP55.

Electrical supply 230V±15%/50-60Hz

#### Construction

- Centrifugal backward curved impeller.
- Steel finger proof guard
- Manufactured from galvanized sheet steel protected with black polyester paint.

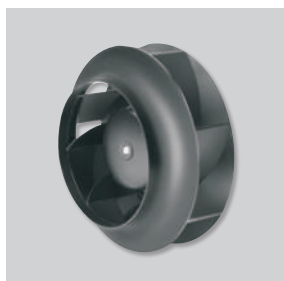

Direct drive backward centrifugal impeller with brushless EC motor.

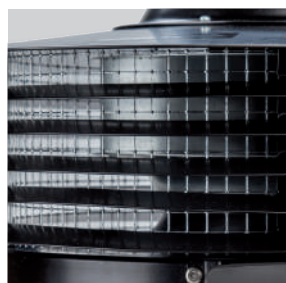

Bird proof guard  
Steel finger proof guard in galvanized sheet.



ON-OFF electrical isolated switch attached to the connection box.



#### Specific applications



Multi dwelling blocks

### TECHNICAL CHARACTERISTICS

Before installation check that the product electrical characteristics listed on the data plate label (Voltage, power, frequency, etc.) match those of the intended electrical supply.

Model	Input signal voltage (V)	Speed (rpm)	Maximum absorbed power (W)	Maximum absorbed current (A)	Maximum airflow (m <sup>3</sup> /h)	Sound pressure level at 4 m* (dB(A))		Weight (kg)
						Inlet	Outlet	
CTB/4-400/160 ECOWATT	10	1485	21,5	0,17	400	34	40	6,0
	8	1365	18,0	0,15	360	32	39	
	6	1100	12,4	0,11	290	27	33	
	4	835	8,7	0,08	220	21	25	
CTB/4-500/200 ECOWATT	10	1490	26,5	0,19	560	36	41	7,0
	8	1395	22,7	0,17	520	34	39	
	6	1150	15,1	0,12	420	30	35	
	4	865	9,4	0,08	320	22	26	
CTB/4-800/250 ECOWATT	10	1430	45,0	0,32	840	38	44	8,5
	8	1260	33,9	0,25	730	36	42	
	6	1060	23,6	0,18	620	31	38	
	4	850	16,7	0,13	500	26	31	
CTB/4-1300/315 ECOWATT	10	1420	91,2	0,62	1490	41	48	10,0
	8	1250	64,7	0,46	1300	38	44	
	6	1050	41,6	0,30	1080	34	41	
	4	860	26,4	0,20	870	30	37	

\* Sound pressure level measured at 4m, roof fan installed on a plan, at the medium working points on the performance curve, shown 2 - 5 - 8 and 11

### DIMENSIONS (mm)

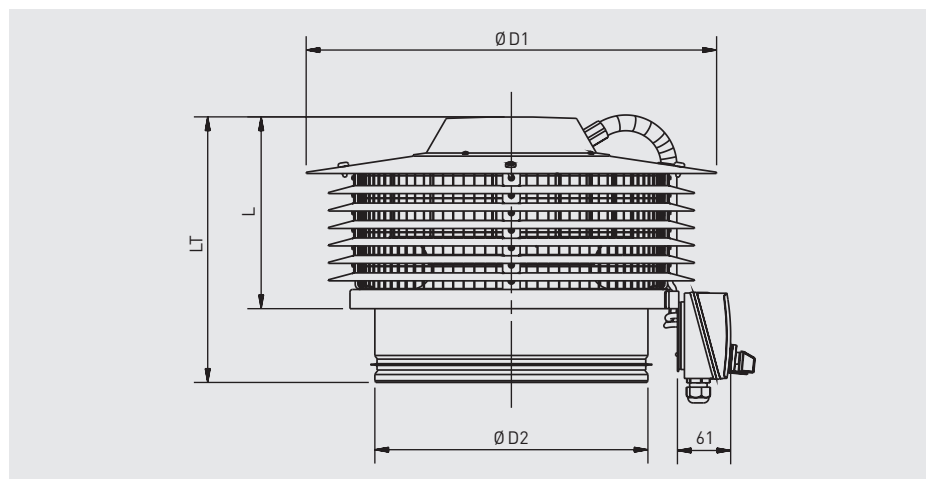

Model	D1	D2	L1	LT
CTB/4-400/160	410	159	143	229
CTB/4-500/200	410	199	156	242
CTB/4-800/250	470	249	179	266
CTB/4-1300/315	470	314	202	288

**PERFORMANCE CURVES - ACOUSTIC CHARACTERISTICS**

- $q_v$ : Airflow in  $m^3/h$ .
- $p_{st}$ : Static pressure in Pa.
- P: Input power in W.
- SFP: Specific fan power in  $W/m^3/s$  (blue curves).
- Performance data in accordance with ISO 5801 and AMCA 210-99 Standards.

CTB-400/160 ECOWATT

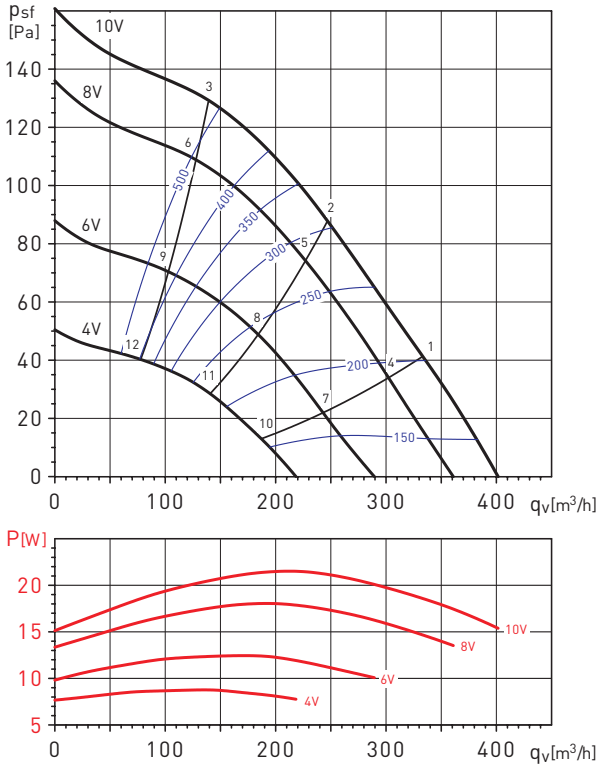

CTB-500/200 ECOWATT

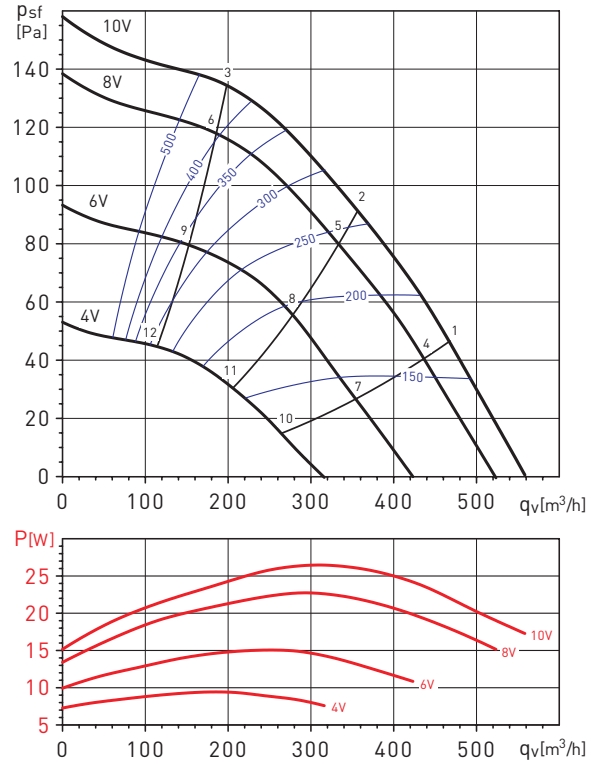

Working point		63	125	250	500	1.000	2.000	4.000	8.000	LwA
1	Inlet	29	36	43	49	51	50	46	37	56
	Outlet	29	37	46	53	57	58	51	38	62
2	Inlet	26	34	42	48	48	48	44	38	54
	Outlet	27	35	45	52	56	57	49	40	60
3	Inlet	32	40	44	48	48	48	44	39	54
	Outlet	35	41	46	52	55	56	48	40	60
4	Inlet	28	36	42	48	49	48	43	34	54
	Outlet	28	37	45	52	56	56	48	36	60
5	Inlet	24	35	41	46	47	46	41	36	52
	Outlet	25	35	43	50	54	55	46	37	59
6	Inlet	29	38	42	46	47	46	42	37	52
	Outlet	31	39	44	50	53	54	46	38	58
7	Inlet	31	31	37	43	44	42	34	27	49
	Outlet	30	32	41	47	50	50	39	27	54
8	Inlet	31	30	36	42	42	41	33	28	47
	Outlet	31	31	40	45	48	48	37	28	53
9	Inlet	32	32	37	41	41	41	34	29	47
	Outlet	32	32	39	45	48	48	38	30	52
10	Inlet	25	30	32	37	36	32	25	24	41
	Outlet	23	35	35	40	42	39	27	24	46
11	Inlet	27	31	32	36	35	31	25	24	41
	Outlet	25	35	35	39	41	38	28	24	45
12	Inlet	23	31	31	35	34	31	26	24	40
	Outlet	24	35	35	38	41	39	28	24	45

Working point		63	125	250	500	1.000	2.000	4.000	8.000	LwA
1	Inlet	30	37	44	51	53	50	51	42	58
	Outlet	31	43	48	54	57	59	55	44	63
2	Inlet	28	37	43	50	51	48	46	41	56
	Outlet	30	42	46	53	56	57	51	43	61
3	Inlet	37	41	45	50	50	48	46	40	56
	Outlet	39	46	49	53	56	57	51	42	61
4	Inlet	29	43	43	49	51	48	49	39	56
	Outlet	29	45	46	52	55	57	53	41	61
5	Inlet	26	43	42	48	49	47	44	38	54
	Outlet	26	45	45	51	54	56	48	40	59
6	Inlet	34	43	43	47	48	46	43	38	54
	Outlet	35	46	45	51	53	55	48	40	59
7	Inlet	29	32	38	44	47	47	39	31	51
	Outlet	27	36	42	48	51	55	44	33	57
8	Inlet	28	33	38	44	45	43	37	30	50
	Outlet	26	36	41	48	50	52	41	32	55
9	Inlet	29	32	37	43	44	42	36	30	49
	Outlet	27	37	41	46	49	50	40	31	54
10	Inlet	25	31	34	37	38	34	26	24	43
	Outlet	24	34	38	41	43	42	29	24	47
11	Inlet	28	31	32	36	37	33	26	24	42
	Outlet	24	34	37	40	41	40	29	25	46
12	Inlet	24	32	31	35	36	33	26	24	41
	Outlet	31	35	38	40	41	41	30	25	46

PERFORMANCE CURVES - ACOUSTIC CHARACTERISTICS

- $q_v$ : Airflow in  $m^3/h$ .
- $p_{st}$ : Static pressure in Pa.
- P: Input power in W.
- SFP: Specific fan power in  $W/m^3/s$  (blue curves).
- Performance data in accordance with ISO 5801 and AMCA 210-99 Standards.

CTB-800/250 ECOWATT

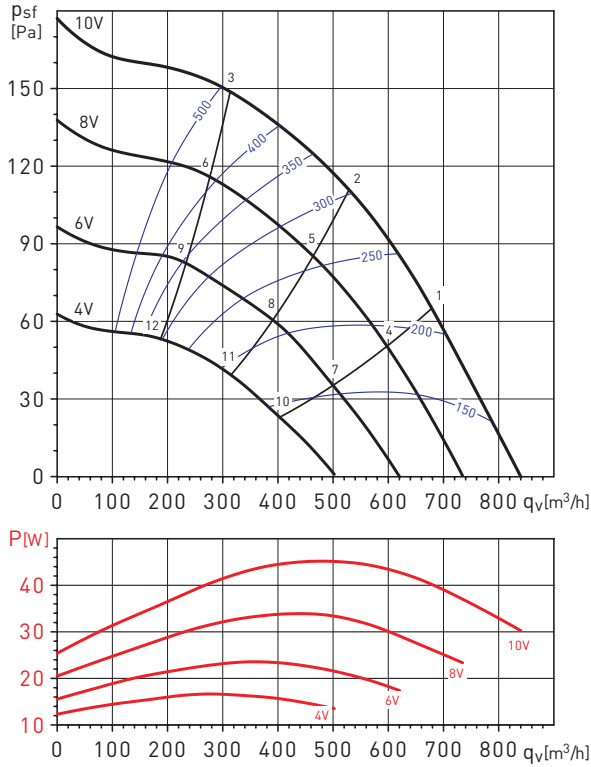

CTB/4-1300/315 ECOWATT

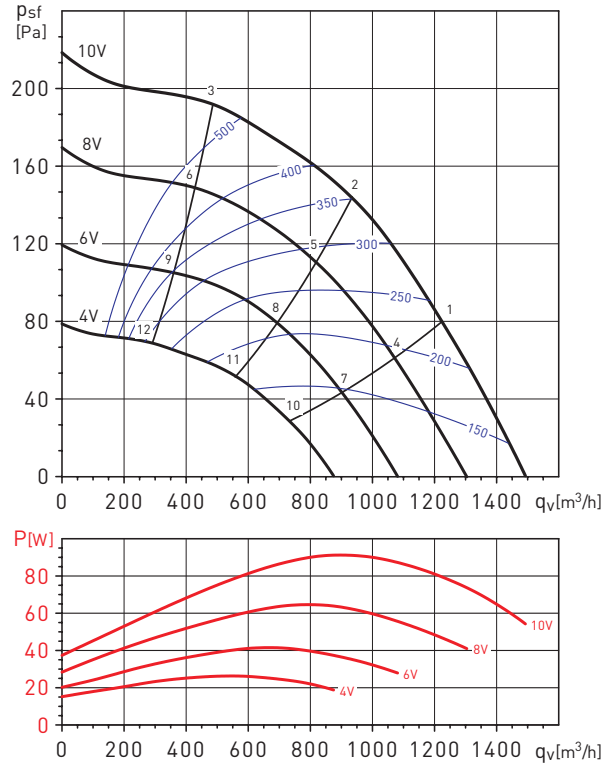

Working point		63	125	250	500	1.000	2.000	4.000	8.000	LwA
1	Inlet	30	38	47	53	54	52	56	47	60
	Outlet	31	42	52	57	61	62	59	50	66
2	Inlet	29	38	46	52	53	51	51	45	58
	Outlet	32	43	51	56	60	60	55	48	64
3	Inlet	43	47	50	54	53	50	49	42	59
	Outlet	44	51	54	58	60	61	55	46	65
4	Inlet	28	40	45	51	52	50	53	43	58
	Outlet	29	43	50	55	59	59	57	46	64
5	Inlet	27	40	44	50	50	49	49	41	56
	Outlet	28	43	48	53	57	58	52	44	62
6	Inlet	40	46	47	50	50	48	46	39	56
	Outlet	41	50	50	55	57	58	51	43	62
7	Inlet	28	33	41	46	48	48	48	36	54
	Outlet	28	36	45	51	54	57	52	40	60
8	Inlet	28	33	40	46	46	45	44	34	51
	Outlet	28	36	44	50	53	54	48	38	58
9	Inlet	34	38	42	46	46	44	39	33	51
	Outlet	35	43	45	50	53	53	44	35	58
10	Inlet	25	34	37	41	41	43	35	30	47
	Outlet	26	38	42	46	49	53	43	33	55
11	Inlet	26	33	35	40	40	40	33	28	46
	Outlet	25	35	38	44	46	47	37	30	51
12	Inlet	30	35	36	39	40	36	31	26	45
	Outlet	34	39	41	44	46	46	35	27	51

Working point		63	125	250	500	1.000	2.000	4.000	8.000	LwA
1	Inlet	30	38	49	55	55	54	60	51	63
	Outlet	31	40	56	60	65	64	63	55	70
2	Inlet	30	39	48	53	54	53	56	49	61
	Outlet	34	43	55	58	63	63	59	53	68
3	Inlet	49	52	55	57	55	52	52	44	62
	Outlet	48	56	59	62	64	64	58	50	69
4	Inlet	27	36	47	52	52	51	57	46	60
	Outlet	29	40	53	58	62	61	61	51	67
5	Inlet	28	36	45	51	51	50	53	44	58
	Outlet	30	40	51	55	60	60	56	48	64
6	Inlet	45	48	50	53	52	49	48	40	58
	Outlet	47	53	54	58	61	61	54	45	66
7	Inlet	27	33	43	48	48	48	56	41	58
	Outlet	28	36	48	54	57	58	59	46	63
8	Inlet	28	33	41	47	47	46	50	38	54
	Outlet	29	35	46	52	56	56	54	43	61
9	Inlet	39	44	46	48	48	45	42	35	54
	Outlet	42	48	49	53	57	56	48	38	61
10	Inlet	25	36	40	44	44	51	44	35	54
	Outlet	27	42	45	51	55	56	57	42	61
11	Inlet	24	35	38	43	43	47	40	32	50
	Outlet	25	36	39	47	51	54	44	35	57
12	Inlet	36	38	40	43	43	39	36	28	49
	Outlet	36	42	43	48	51	50	40	29	55

**ELECTRICAL ACCESSORIES**



**CONTROL ECOWATT AC/DC**  
Control element for demand controlled ventilation systems speed controllers.



**REB-ECOWATT**  
Speed controller for fans fitted with EC motor.



**BEAS**  
Control module adapting an analogical input signal to monitor ECOWATT fans.



**TDP-S / TDP-D**  
Pressure sensor.



**SCO2-A**  
CO<sub>2</sub> and temperature sensor.  
**SCO2-AD**  
CO<sub>2</sub> and temperature sensor, with display.  
**SCHT-AD**  
CO<sub>2</sub>, temperature and relative humidity sensor with display.



**CPFL-S / CPFL-E**  
Presence detector.