



Range of roof mounted mixed flow fans supplied as standard for extract operation. The models 500 and 800 are manufactured from high strength injection moulded plastic, and models 1300 and 2000 from high grade pressed sheet steel. The bases are manufactured from sheet steel. The cowls are manufactured from pressed sheet steel (500 and 800 models) or spun aluminium (1200 and 2000).

All models incorporate a bird guard and base cable gland entry point as standard. All metallic parts are protected with a black epoxy-polyester weatherproof paint coating. The motor and impeller casing can be easily removed by 2 fixing clamps.

Motors

All motors are IP44, Class F, equipped with thermal protection and ball bearings greased for life.

Electrical supply:

Single phase 230V-50Hz (Capacitor located inside the wiring terminal box).

All motor have three speed connections also suitable for voltage speed control using electronic or auto-transformer controllers.

Additional information

Supplied, in the standard version, as extractors. For the TH-500, 800 and 800N models, the motor and impeller casing can be removed and turned through 180° to provide supply air ventilation.



Flame retardant terminal box

Very accessible wiring terminal box in flame retardant plastic V0, with capacitor located inside.

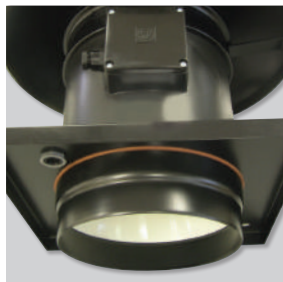

Circular spigot coupling

Circular spigot coupling to facilitate the connection of circular, rigid or flexible ducting.

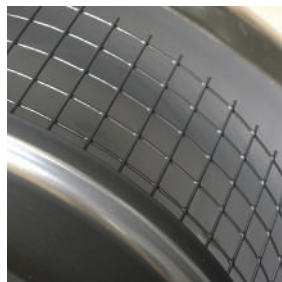

Bird-proof guard.



TECHNICAL CHARACTERISTICS

Before installation check that the product electrical characteristics listed on the data plate label (voltage, power, frequency, etc.) match those of the intended electrical supply.

| Model | | Speed (RPM) | Maximum absorbed power (W) | Maximum absorbed current (A) | Maximum airflow (m³/h) | Sound pressure level* (dB(A)) | | Min-Max air temperature (°C) | Weight (kg) | 3-speed switch | Speed controller | Wiring diagram (n°)** |
|--------------------------------|---------|-------------|----------------------------|------------------------------|------------------------|-------------------------------|--------|------------------------------|-------------|-------------------|--------------------|-----------------------|
| | | | | | | Inlet | Outlet | | | | | |
| TH-500/150 3V TH-500/160 3V | EXTRACT | 2560 | 54 | 0,23 | 500 | 46 | 50 | -20/+60 | 3,8 | COM-3 INTER 4P | RMB-1,5 REB-1 | 53, 54 |
| | | 2120 | 43 | 0,19 | 420 | 43 | 46 | | | | | |
| | | 1790 | 41 | 0,18 | 360 | 38 | 42 | | | | | |
| | SUPPLY | 2540 | 63 | 0,27 | 530 | 48 | 47 | | | | | |
| | | 2170 | 53 | 0,22 | 460 | 44 | 43 | | | | | |
| TH-800N 3V | EXTRACT | 2210 | 101 | 0,49 | 720 | 47 | 52 | -20/+60 | 5,6 | COM-3 INTER 4P | RMB-1,5 REB-1 | 53, 54 |
| | | 1900 | 94 | 0,47 | 620 | 44 | 49 | | | | | |
| | | 1720 | 92 | 0,46 | 540 | 42 | 46 | | | | | |
| | SUPPLY | 2220 | 105 | 0,45 | 830 | 50 | 52 | | | | | |
| | | 1920 | 93 | 0,42 | 710 | 47 | 49 | | | | | |
| TH-800 3V | EXTRACT | 2380 | 117 | 0,51 | 790 | 48 | 52 | -20/+60 | 5,6 | COM-3 INTER 4P | RMB-1,5 REB-1 | 53, 54 |
| | | 2110 | 108 | 0,49 | 680 | 46 | 50 | | | | | |
| | | 1940 | 105 | 0,47 | 610 | 44 | 48 | | | | | |
| | SUPPLY | 2390 | 136 | 0,56 | 890 | 52 | 54 | | | | | |
| | | 2110 | 129 | 0,53 | 780 | 49 | 51 | | | | | |
| TH-1300 3V | EXTRACT | 2480 | 192 | 0,81 | 1060 | 54 | 60 | -40/+60 | 11,2 | COM-3 INTER 4P | RMB-1,5 REB-1 | 55, 56 |
| | | 2140 | 152 | 0,63 | 910 | 51 | 57 | | | | | |
| | | 1920 | 133 | 0,55 | 800 | 49 | 55 | | | | | |
| TH-2000 3V | EXTRACT | 2530 | 301 | 1,14 | 1570 | 57 | 67 | -40/+60 | 17,2 | COM-3 INTER 4P | RMB-1,5 REB-2,5 | 55, 56 |
| | | 2250 | 231 | 0,89 | 1390 | 55 | 65 | | | | | |
| | | 1960 | 183 | 0,71 | 1220 | 51 | 62 | | | | | |

* Sound pressure levels measured at 3 m in free field condition at a medium working point of the performance curve

** See section of Wiring Diagrams.

DIMENSIONS (mm)

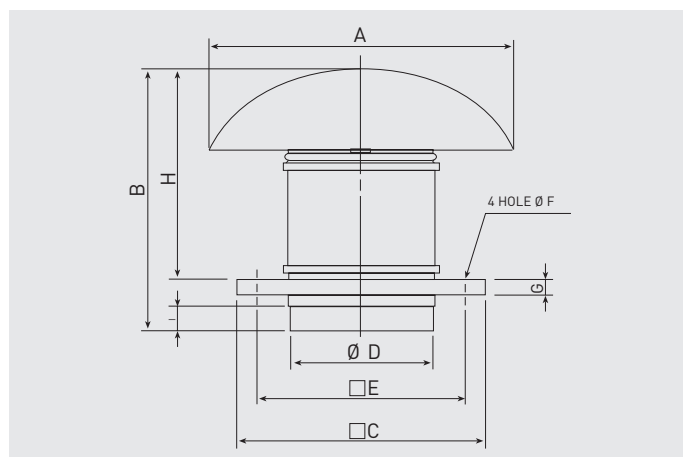

| Model | A | B | C | D | E | F | G | H | I |
|------------|-----|-----|-----|-----|-----|----|----|-----|----|
| TH-500/150 | 400 | 349 | 300 | 150 | 245 | 10 | 20 | 274 | 33 |
| TH-500/160 | 400 | 339 | 300 | 160 | 245 | 10 | 20 | 274 | 33 |
| TH-800 N | 400 | 371 | 300 | 198 | 245 | 10 | 20 | 306 | 36 |
| TH-800 | 400 | 371 | 300 | 198 | 245 | 10 | 20 | 306 | 36 |
| TH-1300 | 546 | 457 | 435 | 248 | 330 | 12 | 20 | 372 | 42 |
| TH-2000 | 735 | 544 | 560 | 312 | 450 | 12 | 20 | 450 | 50 |

PERFORMANCE CURVES - EXTRACT OPERATION

- q_v : Air volume in m^3/h .
- p_{sf} : Static pressure in Pa.
- Dry air at 20°C and 760 mmHg.
- Performance data in accordance with ISO 5801 and AMCA 210-99 Standards.
- SFP: Specific fan power in $W/m^3/s$ (blue curves).

HS: High Speed
MS: Medium Speed
LS: Low Speed

TH-500/150 3V
TH-500/160 3V

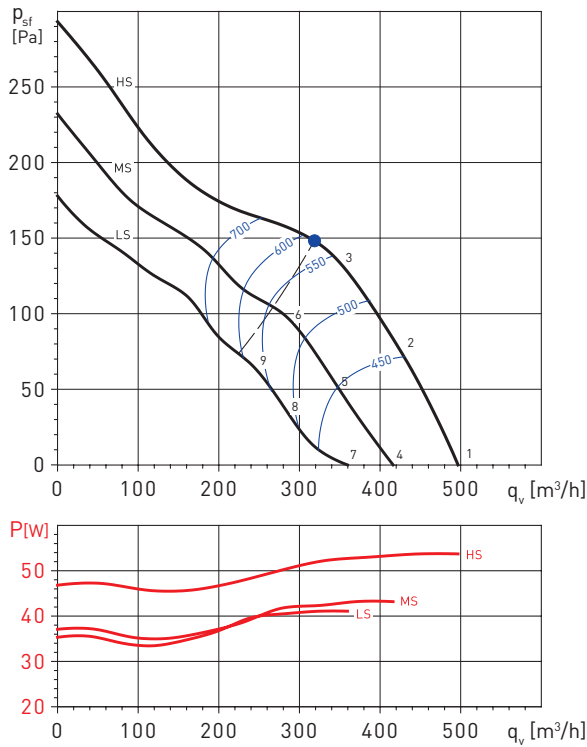

TH-800 N 3V

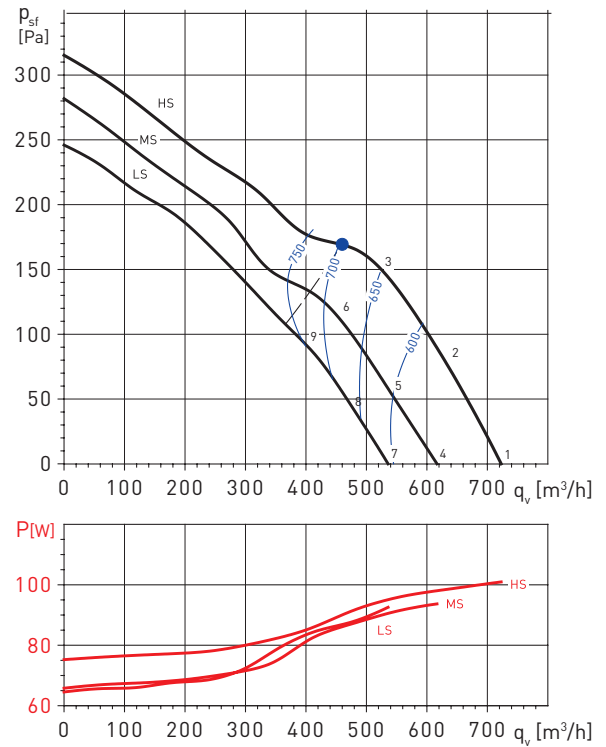

Sound power level spectrums in dB(A)

| Working point | | 63 | 125 | 250 | 500 | 1.000 | 2.000 | 4.000 | 8.000 | LwA |
|---------------|--------|----|-----|-----|-----|-------|-------|-------|-------|-----|
| 1 | Inlet | 35 | 42 | 58 | 64 | 63 | 62 | 57 | 48 | 69 |
| | Outlet | 36 | 44 | 60 | 68 | 68 | 64 | 58 | 48 | 72 |
| 2 | Inlet | 35 | 41 | 55 | 63 | 61 | 60 | 55 | 47 | 67 |
| | Outlet | 36 | 42 | 60 | 67 | 66 | 62 | 55 | 46 | 71 |
| 3 | Inlet | 35 | 41 | 61 | 64 | 61 | 59 | 55 | 47 | 68 |
| | Outlet | 35 | 42 | 61 | 68 | 65 | 61 | 55 | 46 | 71 |
| 4 | Inlet | 31 | 38 | 54 | 60 | 59 | 58 | 53 | 44 | 65 |
| | Outlet | 32 | 40 | 56 | 64 | 64 | 60 | 54 | 44 | 68 |
| 5 | Inlet | 31 | 37 | 51 | 59 | 57 | 56 | 51 | 43 | 63 |
| | Outlet | 32 | 38 | 56 | 63 | 62 | 58 | 51 | 42 | 67 |
| 6 | Inlet | 31 | 37 | 57 | 60 | 57 | 55 | 51 | 43 | 64 |
| | Outlet | 31 | 38 | 57 | 64 | 61 | 57 | 51 | 42 | 67 |
| 7 | Inlet | 27 | 34 | 50 | 56 | 55 | 54 | 49 | 40 | 61 |
| | Outlet | 28 | 36 | 52 | 60 | 60 | 56 | 50 | 40 | 65 |
| 8 | Inlet | 27 | 33 | 47 | 55 | 53 | 52 | 47 | 39 | 59 |
| | Outlet | 28 | 34 | 52 | 59 | 58 | 54 | 47 | 38 | 63 |
| 9 | Inlet | 27 | 33 | 53 | 56 | 53 | 51 | 47 | 39 | 60 |
| | Outlet | 27 | 34 | 53 | 60 | 57 | 53 | 47 | 38 | 63 |

Sound power level spectrums in dB(A)

| Working point | | 63 | 125 | 250 | 500 | 1.000 | 2.000 | 4.000 | 8.000 | LwA |
|---------------|--------|----|-----|-----|-----|-------|-------|-------|-------|-----|
| 1 | Inlet | 40 | 46 | 58 | 65 | 60 | 62 | 57 | 49 | 68 |
| | Outlet | 41 | 50 | 62 | 68 | 68 | 66 | 60 | 51 | 73 |
| 2 | Inlet | 37 | 44 | 55 | 62 | 60 | 63 | 57 | 50 | 67 |
| | Outlet | 38 | 47 | 60 | 68 | 68 | 64 | 58 | 49 | 72 |
| 3 | Inlet | 34 | 44 | 57 | 67 | 63 | 65 | 58 | 51 | 71 |
| | Outlet | 34 | 45 | 57 | 69 | 70 | 63 | 57 | 47 | 73 |
| 4 | Inlet | 37 | 43 | 55 | 62 | 57 | 59 | 54 | 46 | 65 |
| | Outlet | 38 | 47 | 59 | 65 | 65 | 63 | 57 | 48 | 69 |
| 5 | Inlet | 34 | 41 | 52 | 59 | 57 | 60 | 54 | 47 | 64 |
| | Outlet | 35 | 44 | 57 | 65 | 65 | 61 | 55 | 46 | 69 |
| 6 | Inlet | 31 | 41 | 54 | 64 | 60 | 62 | 55 | 48 | 68 |
| | Outlet | 31 | 42 | 54 | 66 | 67 | 60 | 54 | 44 | 70 |
| 7 | Inlet | 34 | 40 | 52 | 59 | 54 | 56 | 51 | 43 | 63 |
| | Outlet | 35 | 44 | 56 | 62 | 62 | 60 | 54 | 45 | 67 |
| 8 | Inlet | 32 | 39 | 50 | 57 | 55 | 58 | 52 | 45 | 62 |
| | Outlet | 33 | 42 | 55 | 63 | 63 | 59 | 53 | 44 | 67 |
| 9 | Inlet | 29 | 39 | 52 | 62 | 58 | 60 | 53 | 46 | 66 |
| | Outlet | 29 | 40 | 52 | 64 | 65 | 58 | 52 | 42 | 68 |

PERFORMANCE CURVES – EXTRACT OPERATION

- q_v : Air volume in m^3/h .
- p_{sf} : Static pressure in Pa.
- Dry air at 20°C and 760 mmHg.
- Performance data in accordance with ISO 5801 and AMCA 210-99 Standards.
- SFP: Specific fan power in $W/m^3/s$ (blue curves).

HS: High Speed
MS: Medium Speed
LS: Low Speed

TH-800 3V

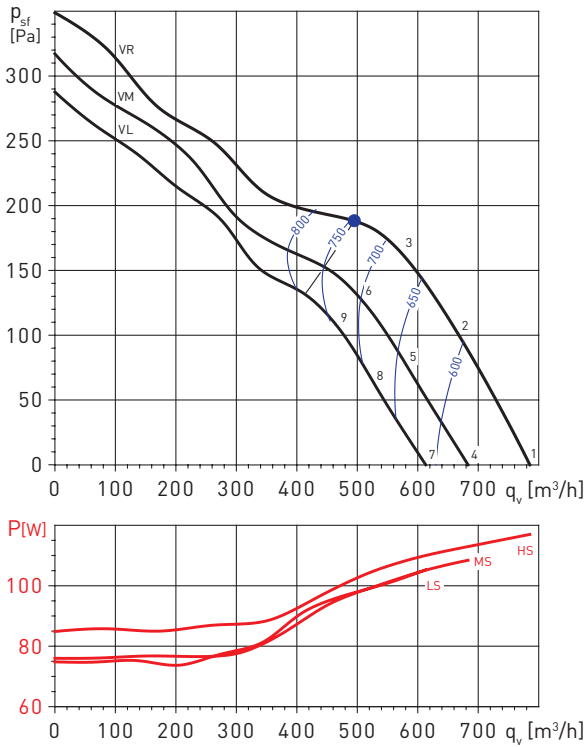

TH-1300 3V

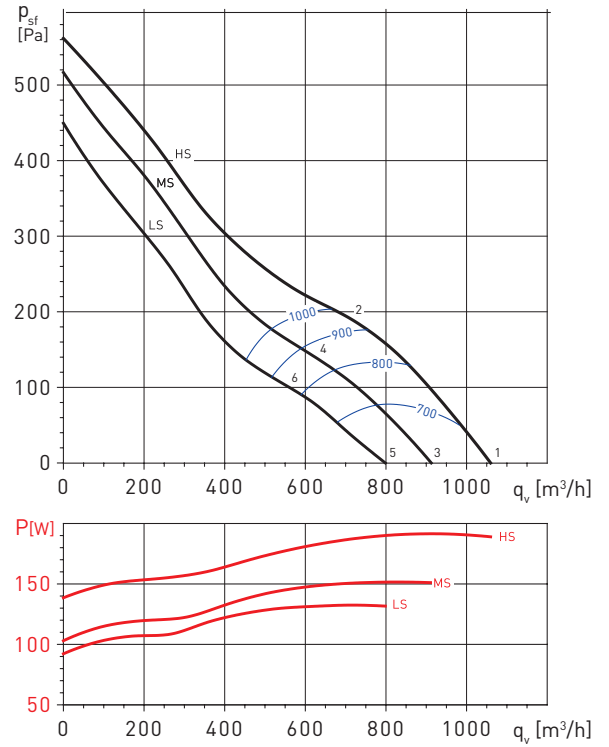

Sound power level spectrums in dB(A)

| Working point | | 63 | 125 | 250 | 500 | 1.000 | 2.000 | 4.000 | 8.000 | LwA |
|---------------|--------|----|-----|-----|-----|-------|-------|-------|-------|-----|
| 1 | Inlet | 41 | 50 | 60 | 66 | 61 | 64 | 60 | 52 | 70 |
| | Outlet | 43 | 52 | 64 | 71 | 70 | 66 | 63 | 54 | 75 |
| 2 | Inlet | 38 | 49 | 56 | 63 | 62 | 64 | 59 | 52 | 69 |
| | Outlet | 39 | 49 | 61 | 68 | 69 | 65 | 60 | 51 | 73 |
| 3 | Inlet | 34 | 48 | 55 | 67 | 63 | 65 | 59 | 53 | 71 |
| | Outlet | 35 | 48 | 57 | 70 | 71 | 64 | 59 | 49 | 74 |
| 4 | Inlet | 38 | 47 | 57 | 63 | 58 | 61 | 57 | 49 | 67 |
| | Outlet | 40 | 49 | 61 | 68 | 67 | 63 | 60 | 51 | 72 |
| 5 | Inlet | 35 | 46 | 53 | 60 | 59 | 61 | 56 | 49 | 66 |
| | Outlet | 36 | 46 | 58 | 65 | 66 | 62 | 57 | 48 | 70 |
| 6 | Inlet | 32 | 46 | 53 | 65 | 61 | 63 | 57 | 51 | 68 |
| | Outlet | 33 | 46 | 55 | 68 | 69 | 62 | 57 | 47 | 72 |
| 7 | Inlet | 36 | 45 | 55 | 61 | 56 | 59 | 55 | 47 | 65 |
| | Outlet | 38 | 47 | 59 | 66 | 65 | 61 | 58 | 49 | 70 |
| 8 | Inlet | 34 | 45 | 52 | 59 | 58 | 60 | 55 | 48 | 64 |
| | Outlet | 35 | 45 | 57 | 64 | 65 | 61 | 56 | 47 | 69 |
| 9 | Inlet | 30 | 44 | 51 | 63 | 59 | 61 | 55 | 49 | 67 |
| | Outlet | 31 | 44 | 53 | 66 | 67 | 60 | 55 | 45 | 70 |

Sound power level spectrums in dB(A)

| Working point | | 63 | 125 | 250 | 500 | 1.000 | 2.000 | 4.000 | 8.000 | LwA |
|---------------|--------|----|-----|-----|-----|-------|-------|-------|-------|-----|
| 1 | Inlet | 38 | 46 | 59 | 60 | 71 | 69 | 63 | 59 | 74 |
| | Outlet | 42 | 49 | 65 | 71 | 77 | 75 | 66 | 59 | 80 |
| 2 | Inlet | 38 | 48 | 63 | 60 | 69 | 67 | 61 | 57 | 72 |
| | Outlet | 39 | 49 | 67 | 71 | 74 | 72 | 64 | 56 | 78 |
| 3 | Inlet | 35 | 43 | 56 | 57 | 68 | 66 | 60 | 56 | 71 |
| | Outlet | 39 | 46 | 62 | 68 | 74 | 72 | 63 | 56 | 77 |
| 4 | Inlet | 36 | 46 | 61 | 58 | 67 | 65 | 59 | 55 | 70 |
| | Outlet | 37 | 47 | 65 | 69 | 72 | 70 | 62 | 54 | 75 |
| 5 | Inlet | 33 | 41 | 54 | 55 | 66 | 64 | 58 | 54 | 69 |
| | Outlet | 37 | 44 | 60 | 66 | 72 | 70 | 61 | 54 | 75 |
| 6 | Inlet | 33 | 43 | 58 | 55 | 64 | 62 | 56 | 52 | 68 |
| | Outlet | 34 | 44 | 62 | 66 | 69 | 67 | 59 | 51 | 73 |

PERFORMANCE CURVES – EXTRACT OPERATION

- q_v : Air volume in m^3/h .
- p_{sf} : Static pressure in Pa.
- Dry air at $20^\circ C$ and 760 mmHg.
- Performance data in accordance with ISO 5801 and AMCA 210-99 Standards.
- SFP: Specific fan power in $W/m^3/s$ (blue curves).

HS: High Speed
MS: Medium Speed
LS: Low Speed

TH-2000 3V

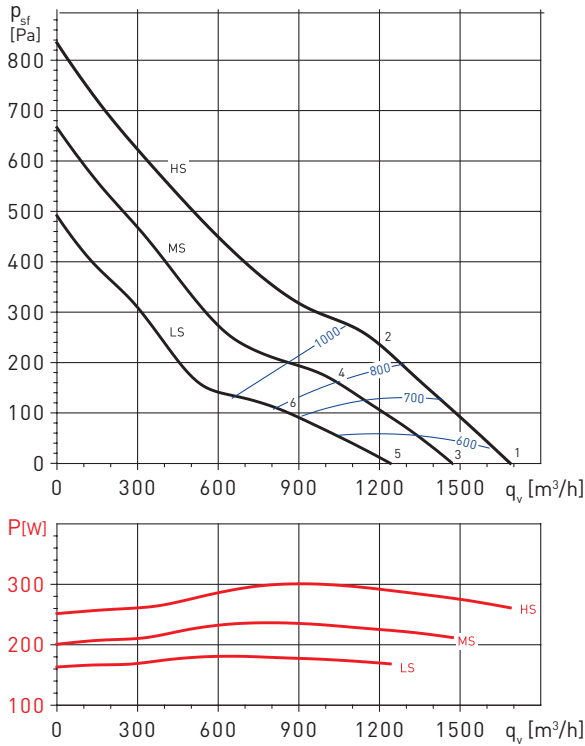

Sound power level spectrums in dB(A)

| Working point | | 63 | 125 | 250 | 500 | 1.000 | 2.000 | 4.000 | 8.000 | LwA |
|---------------|--------|----|-----|-----|-----|-------|-------|-------|-------|-----|
| 1 | Inlet | 38 | 47 | 60 | 64 | 74 | 73 | 65 | 59 | 77 |
| | Outlet | 42 | 52 | 70 | 74 | 87 | 74 | 68 | 59 | 88 |
| 2 | Inlet | 37 | 51 | 70 | 62 | 71 | 71 | 63 | 57 | 76 |
| | Outlet | 38 | 55 | 74 | 72 | 74 | 74 | 65 | 57 | 80 |
| 3 | Inlet | 36 | 45 | 58 | 62 | 72 | 71 | 63 | 57 | 75 |
| | Outlet | 40 | 50 | 68 | 72 | 85 | 72 | 66 | 57 | 86 |
| 4 | Inlet | 33 | 47 | 66 | 58 | 67 | 67 | 59 | 53 | 72 |
| | Outlet | 34 | 51 | 70 | 68 | 70 | 70 | 61 | 53 | 76 |
| 5 | Inlet | 33 | 42 | 55 | 59 | 69 | 68 | 60 | 54 | 72 |
| | Outlet | 37 | 47 | 65 | 69 | 82 | 69 | 63 | 54 | 82 |
| 6 | Inlet | 29 | 43 | 62 | 54 | 63 | 63 | 55 | 49 | 68 |
| | Outlet | 30 | 47 | 66 | 64 | 66 | 66 | 57 | 49 | 72 |

PERFORMANCE CURVES – SUPPLY OPERATION

- q_v : Air volume in m^3/h .
- p_{sf} : Static pressure in Pa.
- Dry air at $20^\circ C$ and 760 mmHg.
- Performance data in accordance with ISO 5801 and AMCA 210-99 Standards.
- SFP: Specific fan power in $W/m^3/s$ (blue curves).

HS: High Speed
MS: Medium Speed
LS: Low Speed

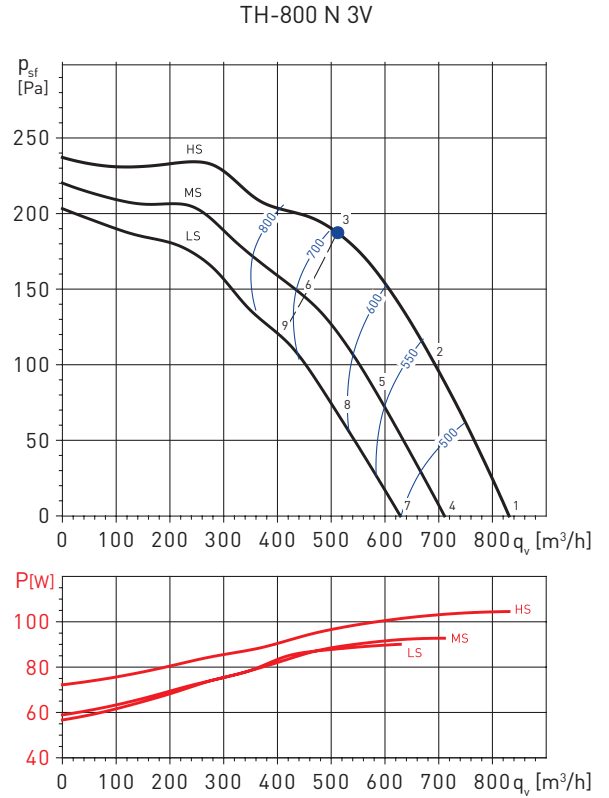
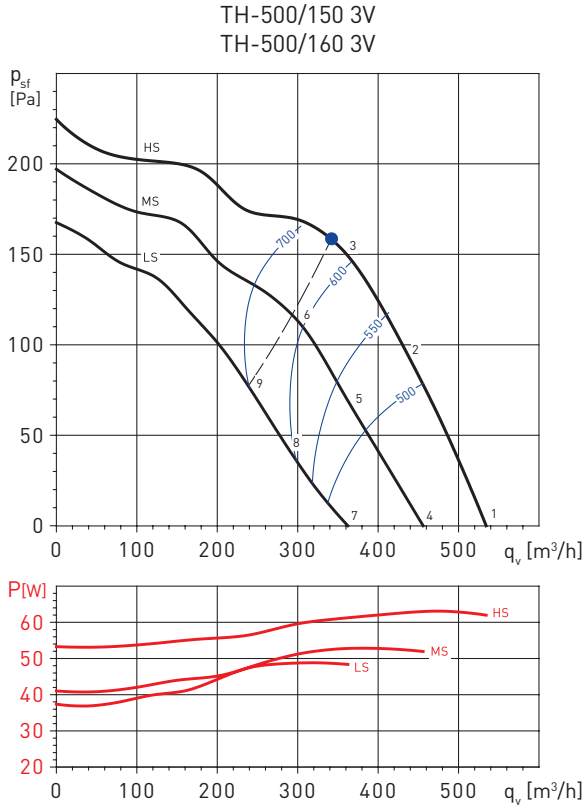

Sound power level spectrums in dB(A)

| Working point | | 63 | 125 | 250 | 500 | 1.000 | 2.000 | 4.000 | 8.000 | LwA |
|---------------|--------|----|-----|-----|-----|-------|-------|-------|-------|-----|
| 1 | Inlet | 30 | 41 | 60 | 66 | 67 | 63 | 55 | 46 | 71 |
| | Outlet | 34 | 41 | 59 | 64 | 65 | 62 | 58 | 51 | 69 |
| 2 | Inlet | 32 | 40 | 59 | 63 | 64 | 60 | 52 | 43 | 68 |
| | Outlet | 34 | 39 | 58 | 62 | 63 | 58 | 56 | 48 | 67 |
| 3 | Inlet | 33 | 40 | 58 | 63 | 64 | 60 | 57 | 44 | 68 |
| | Outlet | 34 | 39 | 58 | 63 | 63 | 58 | 57 | 48 | 68 |
| 4 | Inlet | 26 | 37 | 56 | 62 | 63 | 59 | 51 | 42 | 67 |
| | Outlet | 31 | 38 | 56 | 61 | 62 | 59 | 55 | 48 | 66 |
| 5 | Inlet | 28 | 36 | 55 | 59 | 60 | 56 | 48 | 39 | 64 |
| | Outlet | 30 | 35 | 54 | 58 | 59 | 54 | 52 | 44 | 64 |
| 6 | Inlet | 29 | 36 | 54 | 59 | 60 | 56 | 53 | 40 | 64 |
| | Outlet | 30 | 35 | 54 | 59 | 59 | 54 | 53 | 44 | 64 |
| 7 | Inlet | 22 | 33 | 52 | 58 | 59 | 55 | 47 | 38 | 63 |
| | Outlet | 26 | 33 | 51 | 56 | 57 | 54 | 50 | 43 | 61 |
| 8 | Inlet | 24 | 32 | 51 | 55 | 56 | 52 | 44 | 35 | 60 |
| | Outlet | 26 | 31 | 50 | 54 | 55 | 50 | 48 | 40 | 59 |
| 9 | Inlet | 25 | 32 | 50 | 55 | 56 | 52 | 49 | 36 | 61 |
| | Outlet | 27 | 32 | 51 | 56 | 56 | 51 | 50 | 41 | 60 |

Sound power level spectrums in dB(A)

| Working point | | 63 | 125 | 250 | 500 | 1.000 | 2.000 | 4.000 | 8.000 | LwA |
|---------------|--------|----|-----|-----|-----|-------|-------|-------|-------|-----|
| 1 | Inlet | 35 | 43 | 55 | 65 | 68 | 62 | 56 | 45 | 71 |
| | Outlet | 36 | 44 | 59 | 68 | 69 | 67 | 61 | 51 | 73 |
| 2 | Inlet | 32 | 40 | 54 | 65 | 68 | 60 | 54 | 45 | 70 |
| | Outlet | 33 | 41 | 57 | 67 | 68 | 65 | 60 | 50 | 72 |
| 3 | Inlet | 33 | 43 | 56 | 67 | 69 | 61 | 54 | 45 | 72 |
| | Outlet | 43 | 50 | 61 | 72 | 71 | 66 | 61 | 52 | 75 |
| 4 | Inlet | 32 | 40 | 52 | 62 | 65 | 59 | 53 | 42 | 67 |
| | Outlet | 33 | 41 | 56 | 65 | 66 | 64 | 58 | 48 | 70 |
| 5 | Inlet | 29 | 37 | 51 | 62 | 65 | 57 | 51 | 42 | 67 |
| | Outlet | 30 | 38 | 54 | 64 | 65 | 62 | 57 | 47 | 69 |
| 6 | Inlet | 30 | 40 | 53 | 64 | 66 | 58 | 51 | 42 | 69 |
| | Outlet | 41 | 48 | 59 | 70 | 69 | 64 | 59 | 50 | 73 |
| 7 | Inlet | 29 | 37 | 49 | 59 | 62 | 56 | 50 | 39 | 65 |
| | Outlet | 31 | 39 | 54 | 63 | 64 | 62 | 56 | 46 | 68 |
| 8 | Inlet | 27 | 35 | 49 | 60 | 63 | 55 | 49 | 40 | 65 |
| | Outlet | 28 | 36 | 52 | 62 | 63 | 60 | 55 | 45 | 67 |
| 9 | Inlet | 29 | 39 | 52 | 63 | 65 | 57 | 50 | 41 | 67 |
| | Outlet | 39 | 46 | 57 | 68 | 67 | 62 | 57 | 48 | 71 |

PERFORMANCE CURVES – SUPPLY OPERATION

- q_v : Air volume in m^3/h .
- p_{st} : Static pressure in Pa.
- Dry air at 20°C and 760 mmHg.
- Performance data in accordance with ISO 5801 and AMCA 210-99 Standards.
- SFP: Specific fan power in $W/m^3/s$ (blue curves).

HS: High Speed
MS: Medium Speed
LS: Low Speed

TH-800 3V

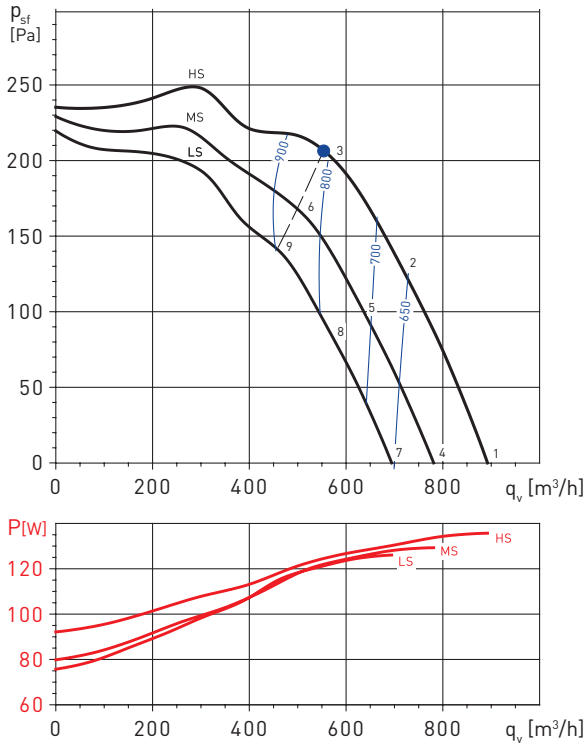

Sound power level spectrums in dB(A)

| Working point | | 63 | 125 | 250 | 500 | 1.000 | 2.000 | 4.000 | 8.000 | LwA |
|---------------|--------|----|-----|-----|-----|-------|-------|-------|-------|-----|
| 1 | Inlet | 37 | 48 | 56 | 67 | 70 | 63 | 58 | 47 | 73 |
| | Outlet | 37 | 47 | 58 | 72 | 72 | 69 | 64 | 54 | 76 |
| 2 | Inlet | 33 | 48 | 54 | 66 | 70 | 62 | 56 | 46 | 72 |
| | Outlet | 34 | 45 | 56 | 69 | 71 | 67 | 62 | 53 | 74 |
| 3 | Inlet | 32 | 48 | 56 | 67 | 71 | 62 | 56 | 47 | 73 |
| | Outlet | 33 | 47 | 56 | 69 | 72 | 67 | 61 | 53 | 75 |
| 4 | Inlet | 34 | 45 | 53 | 64 | 67 | 60 | 55 | 44 | 70 |
| | Outlet | 34 | 44 | 55 | 69 | 69 | 66 | 61 | 51 | 74 |
| 5 | Inlet | 30 | 45 | 51 | 63 | 67 | 59 | 53 | 43 | 69 |
| | Outlet | 31 | 42 | 53 | 66 | 68 | 64 | 59 | 50 | 72 |
| 6 | Inlet | 30 | 46 | 54 | 65 | 69 | 60 | 54 | 45 | 71 |
| | Outlet | 31 | 45 | 54 | 67 | 70 | 65 | 59 | 51 | 73 |
| 7 | Inlet | 32 | 43 | 51 | 62 | 65 | 58 | 53 | 42 | 67 |
| | Outlet | 32 | 42 | 53 | 67 | 67 | 64 | 59 | 49 | 71 |
| 8 | Inlet | 28 | 43 | 49 | 61 | 65 | 57 | 51 | 41 | 67 |
| | Outlet | 29 | 40 | 51 | 64 | 66 | 62 | 57 | 48 | 70 |
| 9 | Inlet | 28 | 44 | 52 | 63 | 67 | 58 | 52 | 43 | 69 |
| | Outlet | 29 | 43 | 52 | 65 | 68 | 63 | 57 | 49 | 71 |

MOUNTING ACCESSORIES

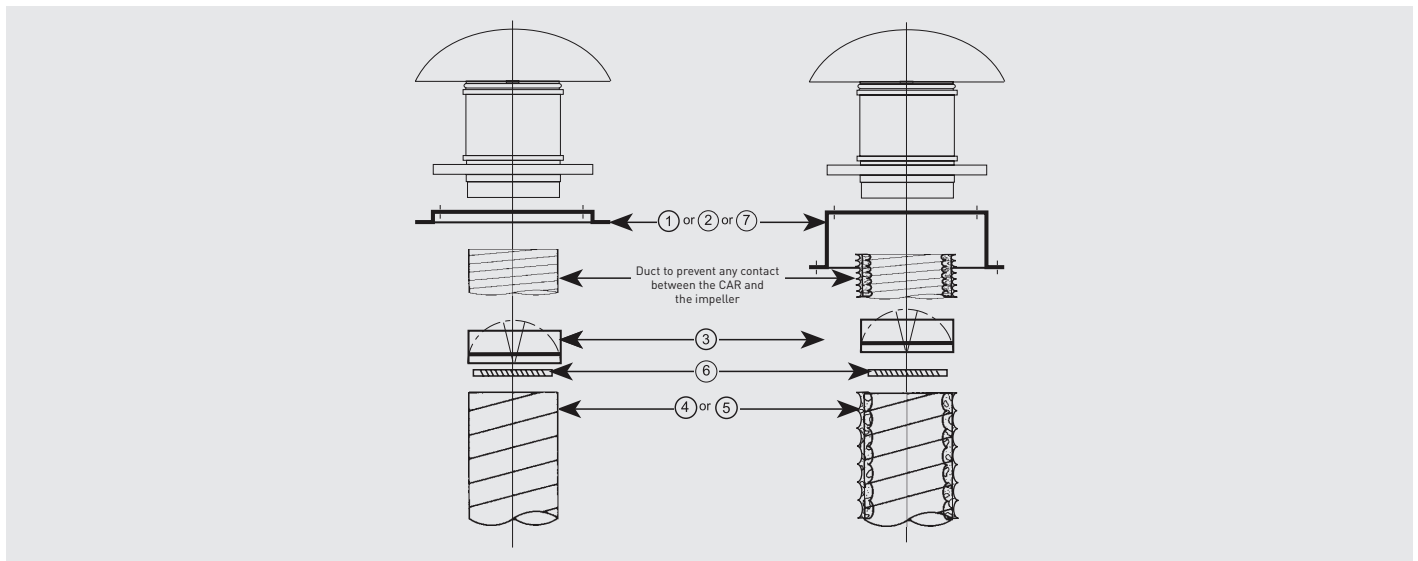

| Model | ① Sealing frame | ② Flat roof upstand | ③ Backdraft shutter | ④ Flexible ducting | ⑤ Flexible acoustic ducting | ⑥ Worm drive clips | ⑦ Support base for curb mounted installations |
|------------|-----------------|---------------------|---------------------|--------------------|-----------------------------|--------------------|---|
| TH-500/150 | JMS-300 | JBS-300 | CAR-150 | GSA-150 | GSI-160 | CX-215 | BI-3 |
| TH-500/160 | JMS-300 | JBS-300 | CAR-160 | GSA-160 | GSI-160 | CX-215 | BI-3 |
| TH-800 N | JMS-300 | JBS-300 | CAR-200 | GSA-200 | GSI-200 | CX-250 | BI-3 |
| TH-800 | JMS-300 | JBS-300 | CAR-200 | GSA-200 | GSI-200 | CX-250 | BI-3 |
| TH-1300 | JMS-435 | JBS-435 | CAR-250 | GSA-250 | GSI-250 | CX-315 | BI-4 |
| TH-2000 | JMS-560 | JBS-560 | CAR-315 | GSA-315 | GSI-315 | CX-315 | BI-5 |

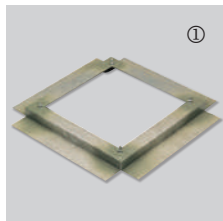

JMS Sealing frame
 - For mounting the roof fans on an up stand or base.
 - Provided with screws and gasket for a complete seal.

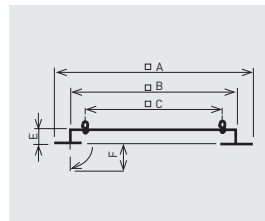

| Model | A | B | C | E | F |
|---------|-----|-----|-----|----|----|
| JMS-300 | 470 | 290 | 245 | 50 | 70 |
| JMS-435 | 600 | 420 | 330 | 50 | 70 |
| JMS-560 | 725 | 545 | 450 | 50 | 70 |

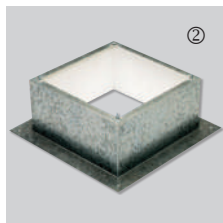

JBS Flat roof up stand
 - For mounting fans on flat roofs with no up stands.
 - Internal insulation to avoid condensation.
 - Provided with screws and gasket for a complete seal.

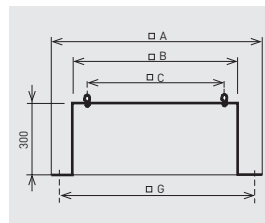

| Model | A | B | C | E | G |
|---------|-----|-----|-----|-----|-----|
| JBS-300 | 470 | 289 | 245 | 300 | 380 |
| JBS-435 | 600 | 419 | 330 | 300 | 510 |
| JBS-560 | 725 | 544 | 450 | 300 | 635 |



BI Support base for inclined curb mounted installations
 - To ensure the proper installation of the BI product it is essential to specify the roof pitch angle and the distance between the roof beam profiles (as shown).

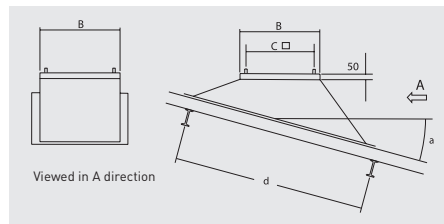

| Model | B | C |
|-------|-----|-----|
| BI-3 | 289 | 245 |
| BI-4 | 419 | 330 |
| BI-5 | 544 | 450 |

d: distance between the roof beam profiles
 a: roof pitch angle (curb)

MOUNTING ACCESSORIES

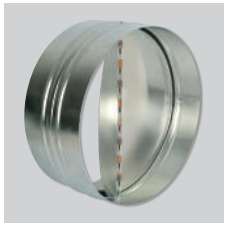

CAR
Backdraft shutter.



GSA
Flexible aluminium ducting.



CX
Worm drive clips.



SIL
Sound attenuator.

GSI
Acoustic aluminium ducting.

ELECTRICAL ACCESSORIES



INTER 4P and COM-3
Three speed switches.



REB
Electronic, single phase speed controller.



RMB
Auto-transformer speed controller