



Constructive configuration Ø 450 models 800, N versions



Constructive configuration Ø 900 and 1000 models, NI versions

Range of cylindrical cased axial flow fans with motor located externally to the fan casing and incorporating a belt driven impeller making this range suitable for continuous operation up to 120°C. The casings are manufactured from high grade rolled sheet steel protected against corrosion by cataphoresis primer and grey polyester paint finish. The drive system consists of an industrial poly V-belt drive pulley system which is enclosed within metal protective guard. All models incorporate die-cast aluminium impellers available with 2 or 3 fixed blade angles. The impellers are finished in red colour epoxy polyester paint coating except Ø 900 and 1000 models.

Motors

All the motors are IP55 class F, fitted with ball bearings greased for life.

Electrical supplies:

Three phase 230/400V-50Hz or 400V-50Hz (see characteristics chart).

Additional information

Standard air direction: form (A) configuration (motor over impeller). NI versions incorporate safety switch, stop / start.

On request

NI versions: fitted with ON / OFF isolation switch.

Single phase 230V-50Hz motors (up to 1.5 kW).

Casing manufactured in stainless steel.

ATEX versions

On request, explosion proof versions in accordance with ATEX Directive, for 3 phase models.

For ambient working temperatures from -20°C to +40°C.

Air direction motor- impeller (A flow)

- ATEX Flameproof - Gas

In standard ATEX version flameproof motors are without thermal protection.

If used with frequency inverter, flameproof motors with a PTC-type thermal protection must be specified at order.

Ⓜ II 2G Ex d IIB T4

Ⓜ II 2G Ex d IIB+H2 T4 (with Ex d IIC T4 motor)

- ATEX Increased safety - Gas

Ⓜ II 2G Ex e II T3

- ATEX - Dust

In standard ATEX version, ATEX motors for dust are without thermal protection.

If used with frequency inverter, ATEX motors for dust with a PTC-type thermal protection must be specified at order.

Suspended flammable particles and non-conductive dust:

Ⓜ II 3D Ex tc IIIB T125°C

Conductive dust:

Ⓜ II 3D Ex tc IIIC T125°C (with IP65 motor)

To select TTT-N ATEX refer to Easyvent. Note electrical data may vary for ATEX motors. Consult availability for other ATEX motor versions.

Specific applications



Continuous



Versions



Easy to maintain

Swing-out fan casing assembly provides an easy access for cleaning or maintenance.



Dynamically balanced impeller

Impellers are dynamically balanced, according to ISO 1940, providing vibration free operation and coated with a special low friction paint repelling the dirtiness.



ON/OFF isolation switch

NI versions fitted with ON/OFF isolation switch.

TECHNICAL CHARACTERISTICS

Before installation check that the product electrical characteristics listed on the data plate label (voltage, power, frequency, etc.) match those of the intended electrical supply.

Model	Speed (rpm)	Diameter (mm)	Motor power (kW)	Maximum absorbed current (A)		Maximum airflow (m³/h)	Sound pressure level* (dB(A))	Weight (kg)
				230 V	400 V			
TTT/4-450/L N	1440	450	0,37	2,1	1,2	5300	68	22
TTT/4-450/H N	1415	450	0,55	2,9	1,7	7400	72	25
TTT/4-500/L N	1400	500	0,55	3,1	1,8	9100	73	37
TTT/4-500/H N	1390	500	0,75	3,6	2,1	10500	75	38
TTT/4-560/L N	1400	560	0,75	3,8	2,2	11500	73	32
TTT/4-560/H N	1420	560	1,1	4,8	2,8	13100	75	35
TTT/4-630/L N	1440	630	1,1	4,8	2,8	13900	75	47
TTT/4-630/H N	1420	630	1,5	6,6	3,8	17200	76	50
TTT/4-710/L N	1460	710	1,5	5,7	3,3	16600	78	57
TTT/4-710/G N	1460	710	2,2	8,0	4,6	20800	78	60
TTT/4-710/H N	1435	710	3	-	6,0	24200	79	64
TTT/4-800/L N	1440	800	2,2	9,2	5,3	25300	80	76
TTT/4-800/G N	1450	800	3	-	6,6	28400	79	79
TTT/4-800/H N	1450	800	4	-	8,6	33300	82	82
TTT/4-900/L N	1460	900	5,5	-	11,8	39500	83	175
TTT/4-900/H N	1470	900	7,5	-	15,2	44000	84	175
TTT/4-1000/L N	1470	1000	7,5	-	15,4	49500	88	208
TTT/4-1000/H N	1450	1000	11	-	21,6	59000	85	232

* Sound pressure in dB(A), measured in free field conditions at a distance equivalent to three times the diameter of the impeller with a minimum of 1.5 meters, in the middle duty point of the performance curve.

DIMENSIONS (mm)

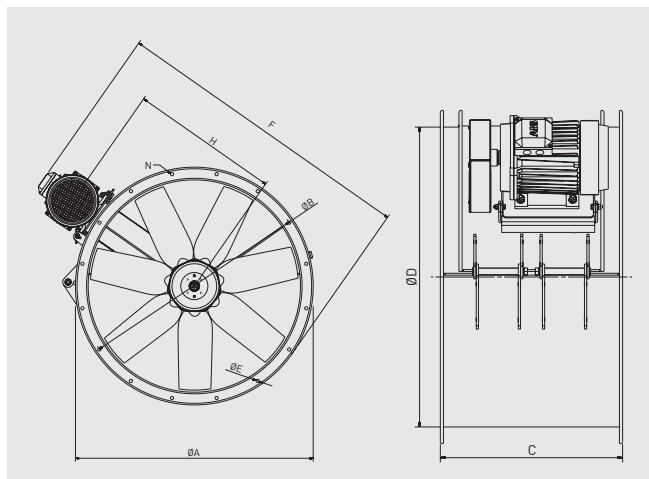

Model	A Ø	B Ø	C	D Ø	E Ø	F	H	Number of holes N
TTT/4-450N	537	500	442	450	12	733	359	8
TTT/4-500N	595	560	450	500	12	790	383	12
TTT/4-560N	655	620	450	560	12	860	422	12
TTT/4-630N	725	690	450	630	12	943	459	12
TTT/4-710N	806	770	490	710	12	1046	507	16
TTT/4-800N	896	860	490	800	12	1145	560	16
TTT/4-900N	1005	970	600	900	15	1330	643	16
TTT/4-1000N	1105	1070	722	1000	15	1505	723	16

MOUNTING ACCESSORIES



Model	Protection grilles (Inlet and discharge)	Circular duct matching flange	Flexible flanged connectors	Support feet	Back draft shutter*
TTT-450N	DEF-450 T	ARO BRIDA COMPACT-450	ACOPEL F400-450/160 N	PIE-450	CLAR-450
TTT-500N	DEF-500 T	ARO BRIDA COMPACT-500	ACOPEL F400-500/160 N	PIE-500	CLAR-500
TTT-560N	DEF-560 T	ARO BRIDA COMPACT-560	ACOPEL F400-560/160 N	PIE-560	CLAR-560
TTT-630N	DEF-630 T	ARO BRIDA COMPACT-630	ACOPEL F400-630/160 N	PIE-630	CLAR-630
TTT-710N	DEF-710 T ASPIRACION	ARO BRIDA COMPACT-710	ACOPEL F400-710/180 N	PIE-700/710	CLAR-710
TTT-800N	DEF-800 T ASPIRACION	ARO BRIDA COMPACT-800	ACOPEL F400-800/180 N	PIE-800	CLAR-800
TTT/4-900N	DEF.ASP.TGT/THGT-900	ARO BRIDA TGT/THGT-900 N	ACOPEL F400-900/180 N	PIE SOP.TGT/THGT-900	CLAR-900
TTT/4-1000N	DEF.ASP.TGT/THGT-1000	ARO BRIDA TGT/THGT-1000 N	ACOPEL F400-1000/180 N	PIE SOP.TGT/THGT-1000	CLAR-1000

* Usable only when impeller shaft is in horizontal position.

PERFORMANCE CURVES

- q_v : Airflow in m^3/h and m^3/s .
- p_{st} : Static pressure in Pa.
- Dry air at $20^\circ C$ and 760 mmHg.
- Performance data in accordance with ISO 5801 and AMCA 210-99 Standards.
- LwA: Sound power level at the inlet side in dB(A).

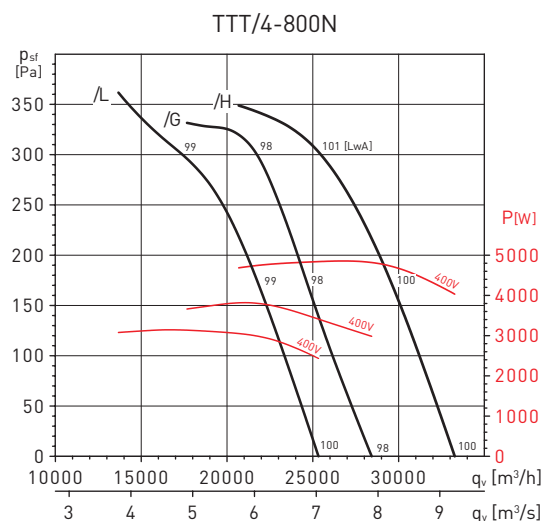
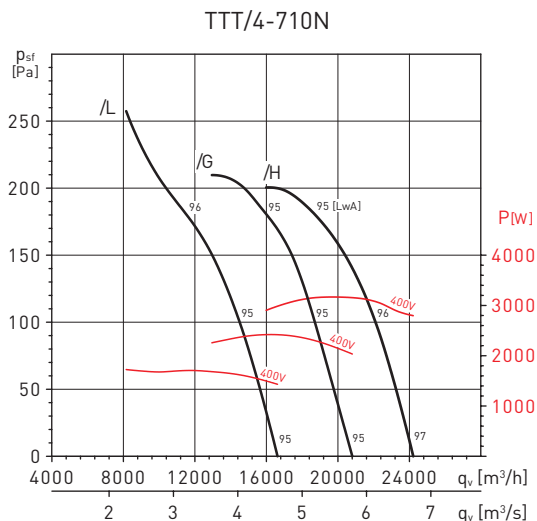
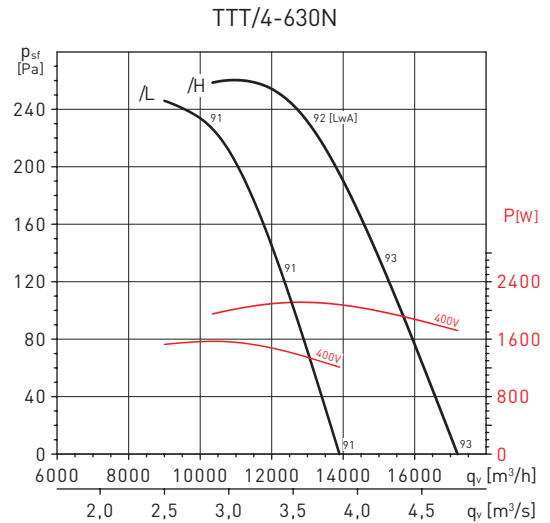
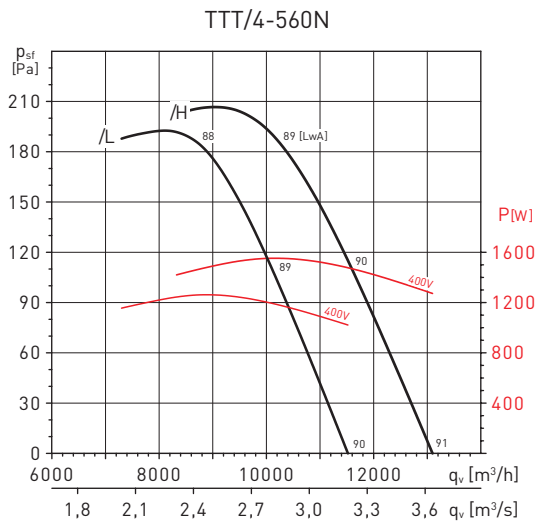
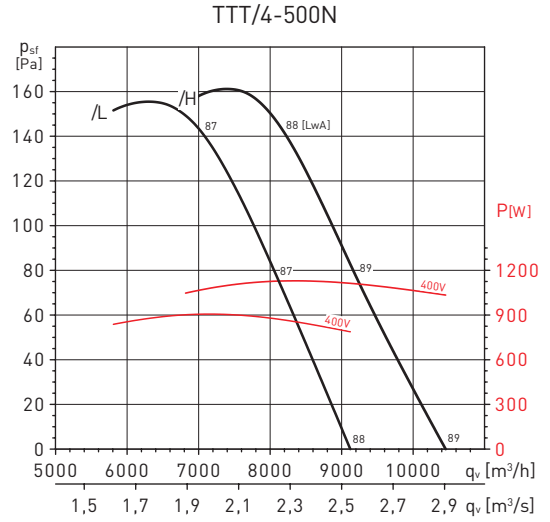
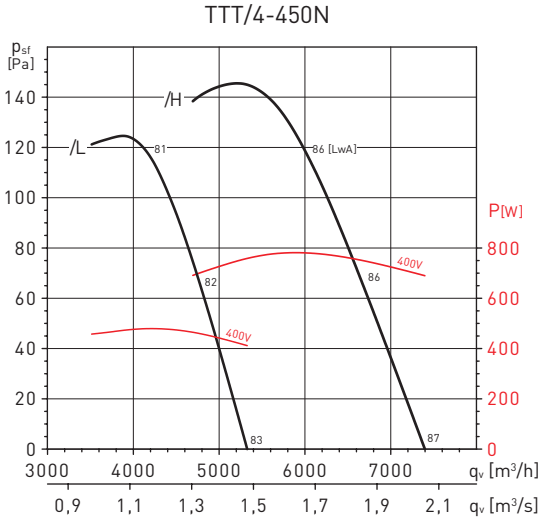

PERFORMANCE CURVES

- q_v : Airflow in m^3/h and m^3/s .
- p_{st} : Static pressure in Pa.
- Dry air at 20°C and 760 mmHg.
- Performance data in accordance with ISO 5801 and AMCA 210-99 Standards.
- LwA: Sound power level at the inlet side in dB(A).

