



Range of in-line fans for circular ducts, designed for high aerodynamic performances with a very compact profiles and very low sound levels.

Low profile compact casing manufactured from galvanised sheet steel. The terminal box and the mounting bracket do not increase the product's profile. Optimised design of the impeller, guide vane and outlet diffuser, manufactured from injection-moulded plastic, to increase performance and lower the sound level.

Airtight joint between the galvanised steel casing and the plastic guide vane to avoid air leaks. Rubber gaskets on the flanges to improve airtightness with the ducts. Silent-block between the motor and the holder to reduce the motor's vibrations and lower the sound level of the installation, even in terms of speed regulation.

Motor

IP65 terminal box allowing outdoor installation.

Fitted with an external rotor brushless EC motor:

- 230V ± 10% 50/60Hz, IP44.
- 100% speed controllable via internal potentiometer located in the terminal box or via 0-10V external signal.
- Ball bearings and thermal protection with manual reset.
- Working temperature: -20/40 °C



DESIGNED FOR AN EASY INSTALLATION

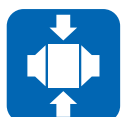

Terminal box
 Built-in, IP65 terminal box that does not add to the overall height dimensions.

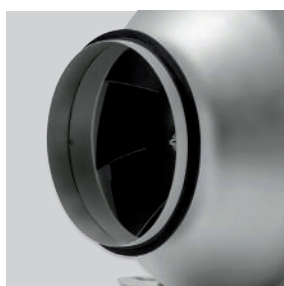

Airtight joints
 Rubber gaskets for a more airtight joint with the installation's ducts.

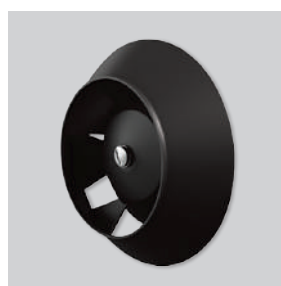

High performance Impeller
 New impeller geometry for reduced sound levels and to offer high performance.

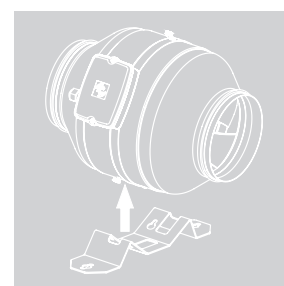

Mounting bracket
 Strong mounting bracket supplied with the fan.

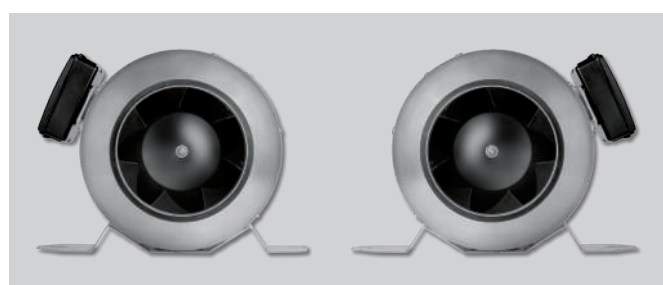

Two mounting positions for support

The product can be mounted in two different positions by changing the position of the support's anchoring.

TECHNICAL CHARACTERISTICS

Before installation check that the product electrical characteristics listed on the data plate label (voltage, power, frequency, etc.) match those of the intended electrical supply.

Model	Input tension regul. (V)	Speed (r.p.m.)	Maximum absorbed power (W)	Maximum absorbed current (A)	Maximum airflow (m ³ /h)	Sound pressure level* (dB(A))			Weight (kg)
						Inlet	Radiated	Outlet	
JETLINE-100 ECOWATT	10	2650	16	0,10	260	41	20	41	2,5
	8	2250	11	0,10	220	38	17	37	
	6	1750	7	0,10	180	32	11	32	
	4	1230	4	0,10	120	25	6	24	
JETLINE-125 ECOWATT	10	2650	26	0,20	390	45	26	45	2,8
	8	2240	17	0,10	330	41	22	42	
	6	1730	9	0,10	260	36	17	36	
	4	1230	5	0,10	190	28	9	29	
JETLINE-150 ECOWATT	10	2650	58	0,50	680	51	33	51	3,6
	8	2260	36	0,30	580	48	29	48	
	6	1740	18	0,20	450	42	24	42	
	4	1240	8	0,10	310	35	16	35	
JETLINE-160 ECOWATT	10	2650	60	0,50	720	51	33	51	3,6
	8	2250	38	0,30	610	48	29	48	
	6	1730	19	0,20	460	42	24	42	
	4	1240	8	0,10	330	35	16	35	
JETLINE-200 ECOWATT	10	2630	109	0,80	1050	55	38	55	4,7
	8	2250	70	0,50	890	52	34	52	
	6	1760	35	0,20	690	46	29	46	
	4	1250	15	0,10	490	39	22	39	
JETLINE-250 ECOWATT	10	2740	135	0,90	1270	58	41	57	5,8
	8	2350	96	0,70	1090	55	38	54	
	6	1830	49	0,40	820	49	32	48	
	4	1290	22	0,20	580	42	24	41	
JETLINE-315 ECOWATT	10	2640	194	1,30	1570	61	45	60	8
	8	2280	129	0,90	1360	58	42	57	
	6	1780	66	0,50	1070	53	36	52	
	4	1260	30	0,20	740	45	29	44	

*Sound pressure level measured at 1,5m in free field conditions, at the duty points 2 - 5 - 8 and 11 of the performance curve.

DIMENSIONS (mm)

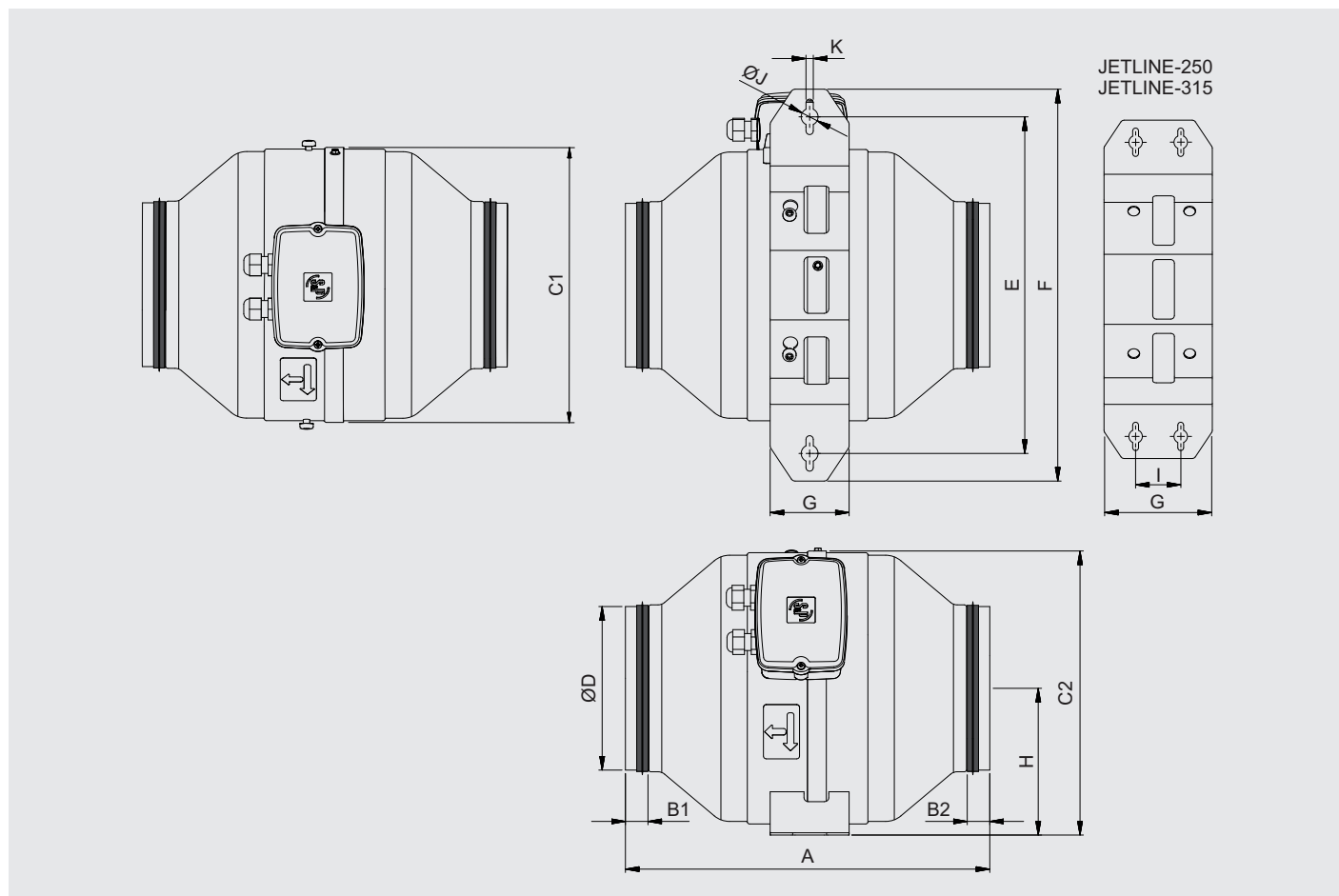

Model	A	B1	B2	C1	C2	D	E	F	G	H	I	J	K
JETLINE-100 ECOWATT	276	15	15	181	190	95	256	306	70	98	-	15	6,5
JETLINE-125 ECOWATT	279	15	15	206	214	120	265	315	70	111	-	15	6,5
JETLINE-150 ECOWATT	323	20	20	243,5	252	145	298,5	348	70	130	-	15	6,5
JETLINE-160 ECOWATT	323	20	20	243,5	252	155	298,5	348	70	130	-	15	6,5
JETLINE-200 ECOWATT	322	30	30	273	281	195	320	369	100	144,5	-	15	6,5
JETLINE-250 ECOWATT	329	20	30	293	301	245	326	375	120	154,3	50	15	6,5
JETLINE-315 ECOWATT	369	20	33	322	331	310	357,5	407	120	170	50	15	6,5

PERFORMANCE CURVES - ACOUSTIC CHARACTERISTICS

- q_v : Airflow in m^3/h .
- p_{sf} : Static pressure in Pa.
- P: Input power in W.
- SFP: Specific fan power in $W/m^3/s$ (blue curves).
- Performance data in accordance with ISO 5801.

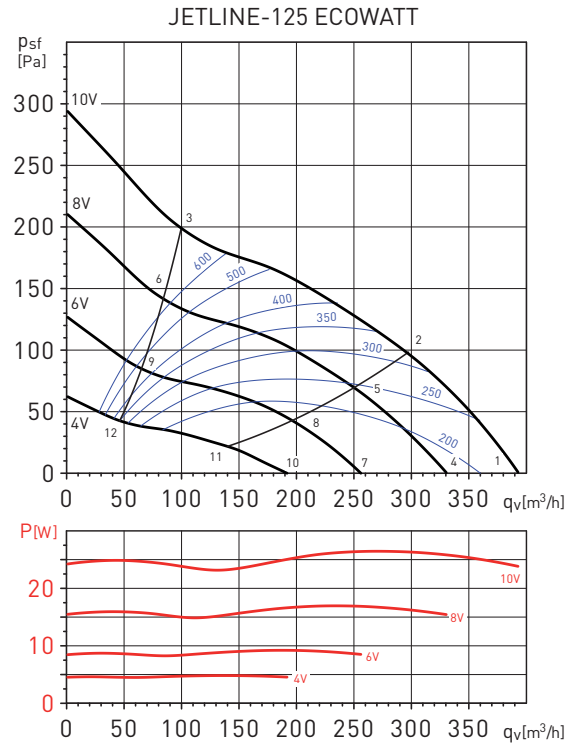
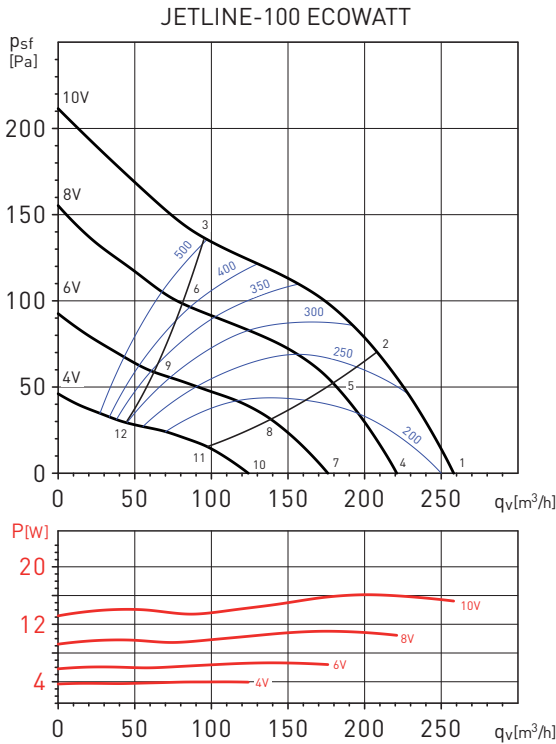

Sound power spectrum (dB(A))

		63	125	250	500	1000	2000	4000	8000	LwA
1	INLET	34	34	45	54	52	51	50	35	58
	OUTLET	27	35	45	52	49	49	47	33	56
	BREAK-OUT	24	15	20	29	31	31	32	19	37
2	INLET	32	34	44	50	49	49	48	34	56
	OUTLET	28	37	44	50	48	47	48	33	55
	BREAK-OUT	22	14	19	25	28	29	30	18	35
3	INLET	33	40	52	55	53	51	50	36	60
	OUTLET	28	42	50	53	52	48	49	35	58
	BREAK-OUT	23	20	27	29	32	30	31	20	38
4	INLET	31	31	41	51	49	48	47	31	55
	OUTLET	24	32	41	48	46	45	43	30	52
	BREAK-OUT	21	12	17	25	28	28	29	16	34
5	INLET	28	30	40	47	46	45	45	31	52
	OUTLET	24	33	40	47	45	43	45	30	52
	BREAK-OUT	18	11	16	21	24	25	27	14	31
6	INLET	30	36	48	51	50	47	46	33	56
	OUTLET	25	39	47	49	48	45	46	31	54
	BREAK-OUT	19	17	24	25	28	27	28	16	34
7	INLET	25	25	36	45	43	42	41	26	49
	OUTLET	18	26	36	43	40	39	38	24	47
	BREAK-OUT	15	6	11	20	22	22	23	10	28
8	INLET	23	25	35	41	40	40	39	25	47
	OUTLET	19	28	35	41	39	38	39	24	46
	BREAK-OUT	13	5	10	16	19	20	21	9	26
9	INLET	24	31	43	46	44	42	41	27	50
	OUTLET	19	33	41	44	43	39	40	25	49
	BREAK-OUT	14	11	18	20	23	21	22	11	28
10	INLET	18	18	28	37	36	34	34	18	42
	OUTLET	11	19	28	35	33	32	30	17	39
	BREAK-OUT	8	2	4	12	15	15	16	3	21
11	INLET	15	17	27	34	33	32	32	17	39
	OUTLET	11	20	27	34	32	30	32	17	39
	BREAK-OUT	5	2	2	8	11	12	14	1	18
12	INLET	17	23	35	38	37	34	33	19	43
	OUTLET	12	26	34	36	35	31	33	18	41
	BREAK-OUT	6	4	11	12	15	14	15	3	21

Sound power spectrum (dB(A))

		63	125	250	500	1000	2000	4000	8000	LwA
1	INLET	35	38	49	57	56	55	55	43	62
	OUTLET	30	38	50	56	54	54	52	41	61
	BREAK-OUT	23	20	26	33	36	37	37	26	42
2	INLET	32	36	47	54	54	53	52	40	60
	OUTLET	31	40	49	55	54	53	52	40	60
	BREAK-OUT	22	18	25	31	35	35	35	24	40
3	INLET	36	43	55	58	58	56	53	41	63
	OUTLET	33	47	54	57	57	55	53	40	63
	BREAK-OUT	24	24	31	33	37	36	35	24	42
4	INLET	31	34	46	54	53	52	51	39	59
	OUTLET	26	35	46	52	51	50	48	37	57
	BREAK-OUT	20	16	22	29	33	33	33	22	39
5	INLET	29	32	44	51	50	49	48	37	56
	OUTLET	27	36	45	51	50	49	48	36	56
	BREAK-OUT	18	15	21	27	31	31	31	21	37
6	INLET	32	40	51	55	54	52	50	38	60
	OUTLET	30	43	51	54	53	51	49	36	59
	BREAK-OUT	20	21	27	30	33	33	31	20	39
7	INLET	25	29	40	48	47	46	45	34	53
	OUTLET	20	29	41	47	45	45	43	31	52
	BREAK-OUT	14	10	17	23	27	27	28	17	33
8	INLET	23	27	38	45	44	44	42	31	50
	OUTLET	22	31	39	46	44	43	43	30	51
	BREAK-OUT	13	9	15	21	25	26	26	15	31
9	INLET	27	34	46	49	48	46	44	32	54
	OUTLET	24	37	45	48	47	45	43	30	53
	BREAK-OUT	15	15	22	24	28	27	26	15	33
10	INLET	18	21	33	41	39	39	38	26	46
	OUTLET	13	22	33	39	38	37	35	24	44
	BREAK-OUT	7	3	9	16	20	20	20	9	25
11	INLET	16	19	31	38	37	36	35	24	43
	OUTLET	14	23	32	38	37	36	35	23	43
	BREAK-OUT	5	2	8	14	18	18	18	8	24
12	INLET	19	27	38	42	41	39	37	25	47
	OUTLET	17	30	38	41	40	38	36	23	46
	BREAK-OUT	7	8	14	17	20	20	18	7	26

PERFORMANCE CURVES - ACOUSTIC CHARACTERISTICS

- q_v : Airflow in m^3/h .
- p_{sf} : Static pressure in Pa.
- P: Input power in W.
- SFP: Specific fan power in $W/m^3/s$ (blue curves).
- Performance data in accordance with ISO 5801.

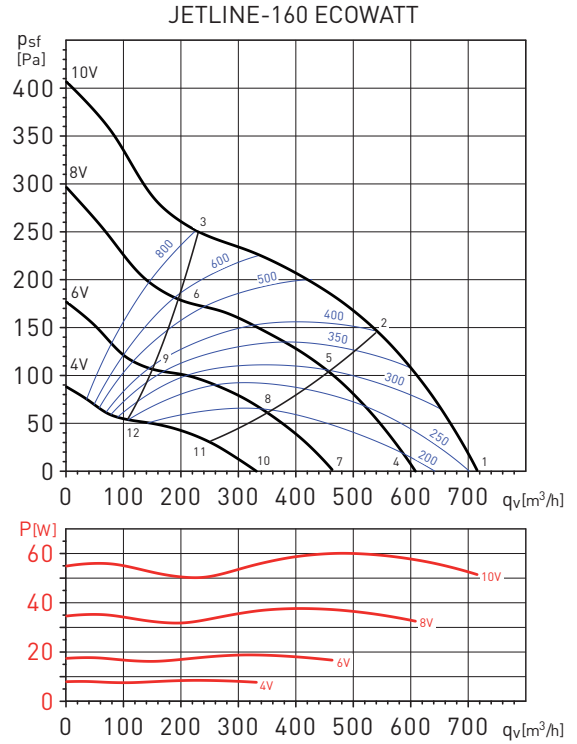
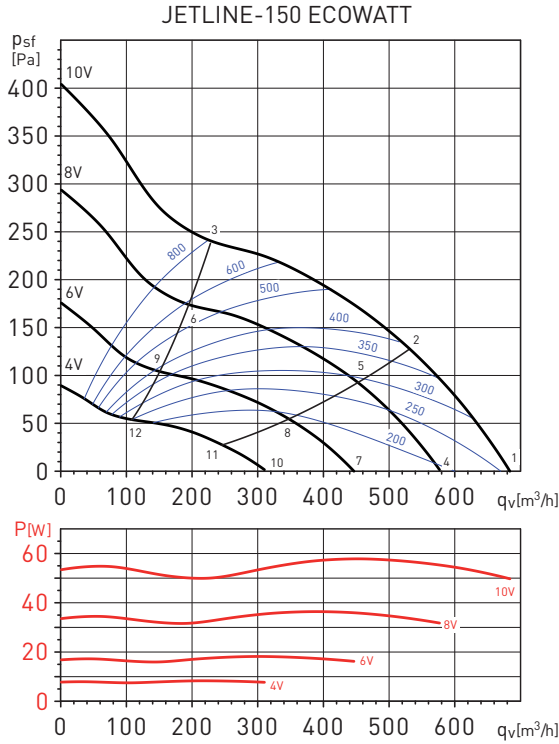

Sound power spectrum (dB(A))

		63	125	250	500	1000	2000	4000	8000	LwA
1	INLET	35	43	55	61	61	61	60	53	67
	OUTLET	34	43	57	62	61	61	59	51	68
	BREAK-OUT	23	25	33	38	43	44	43	35	49
2	INLET	34	40	53	60	60	59	57	49	66
	OUTLET	34	43	54	60	60	60	56	47	66
	BREAK-OUT	22	23	31	37	42	42	41	32	47
3	INLET	40	48	59	63	63	62	58	48	69
	OUTLET	39	50	58	61	62	62	56	45	68
	BREAK-OUT	27	30	37	39	44	45	40	30	49
4	INLET	32	39	52	58	58	57	56	49	64
	OUTLET	30	39	54	59	58	58	55	47	64
	BREAK-OUT	19	22	30	35	40	41	40	32	46
5	INLET	31	36	50	57	57	56	53	46	62
	OUTLET	31	40	51	57	57	56	52	44	62
	BREAK-OUT	18	19	28	34	39	39	37	28	44
6	INLET	36	44	56	59	59	59	54	45	65
	OUTLET	35	47	55	58	59	58	53	42	64
	BREAK-OUT	23	26	33	36	41	41	37	27	46
7	INLET	26	33	46	52	52	52	51	44	58
	OUTLET	24	34	48	53	52	52	50	41	59
	BREAK-OUT	14	16	24	29	34	35	34	26	40
8	INLET	25	31	44	51	51	50	48	40	56
	OUTLET	25	34	45	51	51	50	47	38	56
	BREAK-OUT	13	14	22	28	33	33	31	23	38
9	INLET	30	39	50	54	54	53	49	39	59
	OUTLET	30	41	49	52	53	53	47	36	58
	BREAK-OUT	17	21	27	30	35	35	31	21	40
10	INLET	19	26	39	45	45	44	43	36	51
	OUTLET	17	26	41	46	45	45	42	34	51
	BREAK-OUT	6	9	17	22	27	28	27	19	33
11	INLET	18	23	37	44	44	43	40	33	49
	OUTLET	18	27	38	44	44	43	39	31	49
	BREAK-OUT	5	6	15	21	26	26	24	15	31
12	INLET	23	31	43	46	46	46	41	32	52
	OUTLET	22	34	42	45	46	45	40	29	51
	BREAK-OUT	10	13	20	23	28	28	24	14	33

Sound power spectrum (dB(A))

		63	125	250	500	1000	2000	4000	8000	LwA
1	INLET	35	43	55	61	61	61	60	53	67
	OUTLET	34	43	57	62	61	61	59	51	68
	BREAK-OUT	23	25	33	38	43	44	43	35	49
2	INLET	34	40	53	60	60	59	57	49	66
	OUTLET	34	43	54	60	60	60	56	47	66
	BREAK-OUT	22	23	31	37	42	42	41	32	47
3	INLET	40	48	59	63	63	62	58	48	69
	OUTLET	39	50	58	61	62	62	56	45	68
	BREAK-OUT	27	30	37	39	44	45	40	30	49
4	INLET	32	39	52	58	58	57	56	49	64
	OUTLET	30	39	54	59	58	58	55	47	64
	BREAK-OUT	19	22	30	35	40	40	40	32	46
5	INLET	31	36	50	56	56	56	53	46	62
	OUTLET	31	40	51	57	57	56	52	44	62
	BREAK-OUT	18	19	28	34	39	39	37	28	44
6	INLET	36	44	56	59	59	59	54	45	65
	OUTLET	35	47	55	58	59	58	53	42	64
	BREAK-OUT	23	26	33	36	41	41	37	27	46
7	INLET	26	33	46	52	52	52	51	44	58
	OUTLET	24	34	48	53	52	52	50	41	59
	BREAK-OUT	14	16	24	29	34	35	34	26	40
8	INLET	25	31	44	51	51	50	48	40	56
	OUTLET	25	34	45	51	51	50	47	38	56
	BREAK-OUT	13	14	22	28	33	33	31	23	38
9	INLET	30	38	50	54	54	53	49	39	59
	OUTLET	30	41	49	52	53	53	47	36	58
	BREAK-OUT	17	21	27	30	35	35	31	21	40
10	INLET	18	26	39	45	45	44	43	36	51
	OUTLET	17	26	41	46	45	45	42	34	51
	BREAK-OUT	6	9	17	22	27	28	27	19	33
11	INLET	18	23	37	44	44	43	40	33	49
	OUTLET	18	27	38	44	44	43	39	31	49
	BREAK-OUT	5	6	15	21	26	26	24	15	31
12	INLET	23	31	43	46	46	46	41	32	52
	OUTLET	22	34	42	45	46	45	40	29	51
	BREAK-OUT	10	13	20	23	28	28	24	14	33

PERFORMANCE CURVES - ACOUSTIC CHARACTERISTICS

- q_v : Airflow in m^3/h .
- p_{sf} : Static pressure in Pa.
- P: Input power in W.
- SFP: Specific fan power in $W/m^3/s$ (blue curves).
- Performance data in accordance with ISO 5801.

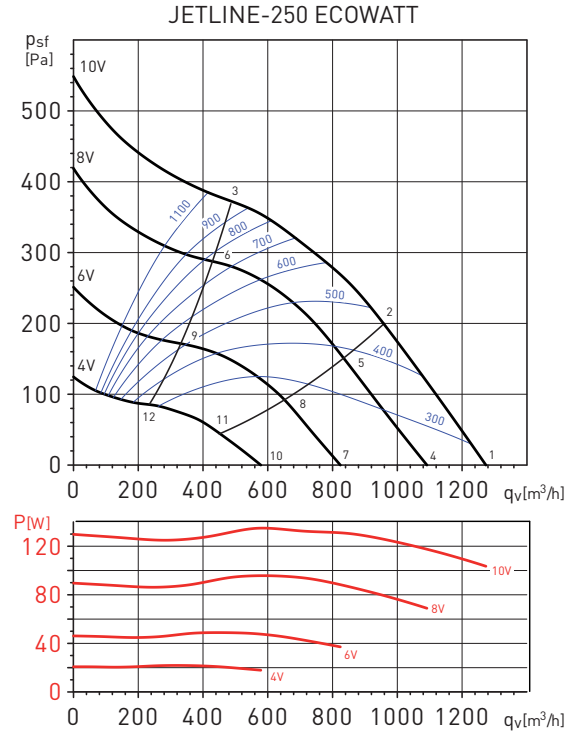
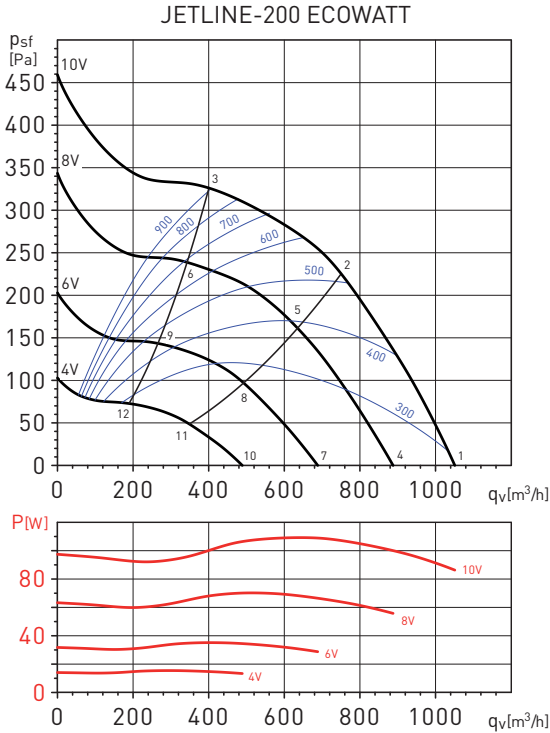

Sound power spectrum (dB(A))

		63	125	250	500	1000	2000	4000	8000	LwA
1	INLET	36	46	60	65	65	65	64	60	72
	OUTLET	36	45	62	66	65	66	63	57	72
	BREAK-OUT	22	29	38	42	47	48	47	41	53
2	INLET	35	42	57	64	65	63	60	55	70
	OUTLET	37	46	58	63	64	64	58	52	70
	BREAK-OUT	22	26	36	42	48	47	45	37	52
3	INLET	42	50	62	66	66	66	61	52	72
	OUTLET	42	53	61	64	65	66	58	48	71
	BREAK-OUT	28	33	40	43	48	49	43	33	53
4	INLET	33	43	57	61	62	62	61	57	68
	OUTLET	32	42	58	62	62	62	59	53	68
	BREAK-OUT	19	25	35	38	44	45	44	38	50
5	INLET	32	39	54	61	61	60	57	52	66
	OUTLET	33	42	55	60	61	61	55	49	66
	BREAK-OUT	19	23	33	39	44	44	41	34	49
6	INLET	38	47	58	62	63	63	57	49	68
	OUTLET	39	49	57	61	62	63	55	45	67
	BREAK-OUT	24	29	36	39	45	46	40	30	50
7	INLET	27	37	51	56	56	56	55	51	63
	OUTLET	27	36	53	57	57	57	54	48	63
	BREAK-OUT	13	20	29	33	38	40	38	32	44
8	INLET	26	34	48	55	56	54	51	46	61
	OUTLET	28	37	49	55	56	55	50	44	61
	BREAK-OUT	13	17	27	33	39	39	36	28	43
9	INLET	33	41	53	57	57	57	52	44	63
	OUTLET	33	44	52	55	56	57	49	39	62
	BREAK-OUT	19	24	31	34	39	41	35	25	44
10	INLET	20	30	44	49	49	49	48	44	55
	OUTLET	19	29	46	49	49	50	47	40	56
	BREAK-OUT	6	13	22	25	31	32	31	25	37
11	INLET	19	26	41	48	48	47	44	39	54
	OUTLET	21	29	42	47	48	48	42	36	53
	BREAK-OUT	6	10	20	26	32	31	29	21	36
12	INLET	25	34	46	49	50	50	44	36	56
	OUTLET	26	36	44	48	49	50	42	32	55
	BREAK-OUT	11	17	24	27	32	33	27	17	37

Sound power spectrum (dB(A))

		63	125	250	500	1000	2000	4000	8000	LwA
1	INLET	36	48	62	66	67	67	66	64	74
	OUTLET	36	46	64	67	67	68	65	60	74
	BREAK-OUT	22	31	41	44	50	52	50	45	56
2	INLET	36	45	60	67	68	66	63	59	73
	OUTLET	38	47	60	65	67	67	60	55	72
	BREAK-OUT	22	28	39	45	51	50	47	40	55
3	INLET	43	52	63	67	68	69	62	55	74
	OUTLET	45	55	63	67	68	70	60	51	74
	BREAK-OUT	29	35	42	45	51	53	46	36	56
4	INLET	33	45	59	63	64	64	63	61	70
	OUTLET	33	43	61	64	64	65	62	57	70
	BREAK-OUT	19	28	38	41	47	48	46	42	53
5	INLET	33	41	57	63	64	63	60	56	69
	OUTLET	34	43	57	62	63	63	56	52	68
	BREAK-OUT	19	25	35	41	48	47	44	37	52
6	INLET	40	49	60	64	65	66	59	52	71
	OUTLET	42	52	60	63	65	67	57	48	71
	BREAK-OUT	25	32	39	42	48	50	42	33	53
7	INLET	27	39	54	58	58	59	58	55	65
	OUTLET	28	37	55	59	59	59	56	51	65
	BREAK-OUT	13	23	32	35	42	43	41	36	47
8	INLET	28	36	51	58	59	57	54	51	64
	OUTLET	29	38	52	56	58	58	51	46	63
	BREAK-OUT	13	19	30	36	42	42	38	32	47
9	INLET	34	43	55	59	59	60	54	46	65
	OUTLET	37	46	54	58	59	61	51	43	65
	BREAK-OUT	20	26	33	37	43	44	37	27	48
10	INLET	20	32	46	50	51	51	50	48	57
	OUTLET	20	30	48	51	51	52	48	44	57
	BREAK-OUT	6	15	25	28	34	35	33	29	40
11	INLET	20	28	44	50	51	50	46	43	56
	OUTLET	21	30	44	49	50	50	43	39	55
	BREAK-OUT	6	11	22	28	35	34	31	24	39
12	INLET	27	36	47	51	52	52	46	39	58
	OUTLET	29	39	47	50	52	54	44	35	58
	BREAK-OUT	12	19	26	29	35	37	29	20	40

PERFORMANCE CURVES - ACOUSTIC CHARACTERISTICS

- q_v : Airflow in m^3/h .
- p_{sf} : Static pressure in Pa.
- P: Input power in W.
- SFP: Specific fan power in $W/m^3/s$ (blue curves).
- Performance data in accordance with ISO 5801.

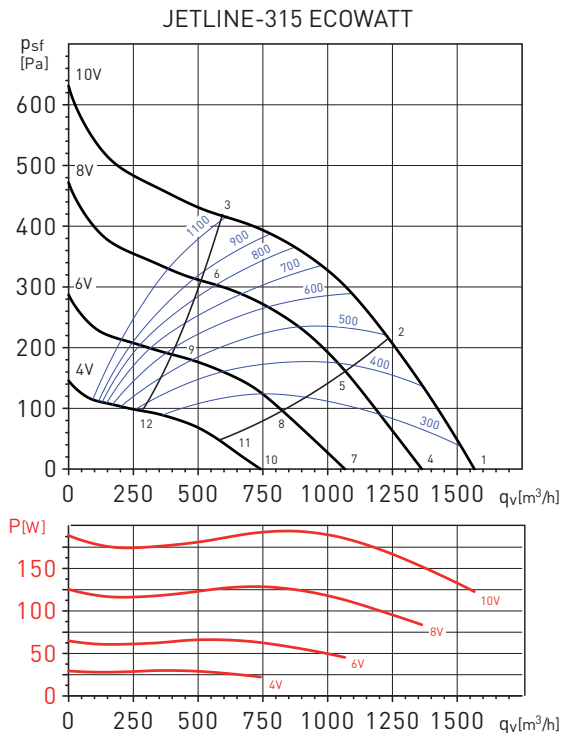

Sound power spectrum (dB(A))

		63	125	250	500	1000	2000	4000	8000	LwA
1	INLET	36	50	65	68	69	70	69	69	76
	OUTLET	38	48	67	70	71	71	68	64	77
	BREAK-OUT	22	35	45	47	54	56	53	50	60
2	INLET	37	47	63	70	71	69	65	64	76
	OUTLET	40	48	63	68	70	70	62	59	75
	BREAK-OUT	23	31	43	48	55	55	50	45	59
3	INLET	44	54	65	69	70	72	64	58	76
	OUTLET	47	56	65	68	70	73	61	54	76
	BREAK-OUT	30	37	44	48	54	57	48	38	60
4	INLET	33	47	62	65	66	66	65	65	73
	OUTLET	35	45	64	67	67	68	65	61	74
	BREAK-OUT	19	32	42	44	51	53	50	47	57
5	INLET	34	43	60	66	68	66	62	61	73
	OUTLET	36	45	60	65	67	67	58	56	72
	BREAK-OUT	20	27	39	45	52	51	47	41	56
6	INLET	41	50	62	66	67	68	61	55	73
	OUTLET	44	53	61	65	67	70	58	50	73
	BREAK-OUT	26	34	41	45	51	53	45	35	56
7	INLET	27	41	56	59	61	61	60	60	68
	OUTLET	29	39	59	61	62	63	59	56	68
	BREAK-OUT	14	26	37	39	46	47	45	41	52
8	INLET	29	38	54	61	62	61	57	55	67
	OUTLET	31	40	55	59	61	62	53	50	66
	BREAK-OUT	14	22	34	40	47	46	42	36	51
9	INLET	36	45	56	61	62	63	56	49	67
	OUTLET	39	48	56	60	62	64	53	45	68
	BREAK-OUT	21	29	36	39	46	48	39	30	51
10	INLET	20	34	49	52	53	54	53	53	60
	OUTLET	22	32	51	54	55	55	52	48	61
	BREAK-OUT	6	19	30	32	38	40	37	34	44
11	INLET	21	31	47	54	55	53	49	48	60
	OUTLET	24	32	47	52	54	54	46	43	59
	BREAK-OUT	7	15	27	33	40	39	35	29	43
12	INLET	28	38	49	53	54	56	48	42	60
	OUTLET	32	41	49	52	54	57	45	38	60
	BREAK-OUT	14	22	29	32	39	41	32	23	44

MOUNTING ACCESSORIES



MBE
Electric heater.



MBW
Hot water coil.



SIL
Circular sound attenuators.

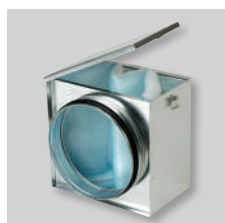

MFL-G4
Filtration box of G4 grade filtration.

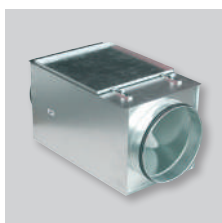

MFL-F
Box in galvanized steel for inserting the MFR F5, F6 and F7 filters.



CAR
Backdraught shutters.



GSA M0
Aluminium flexible ducting.



GSI M0
Insulated aluminium ducting.



CX
Worm drive duct connectors.



BOC
Metal inlet valves.



BOR
Plastic inlet valves.



GCI
Circular inlet grilles.



VR
GCI mounting frame.



GRI
Interior square grilles.

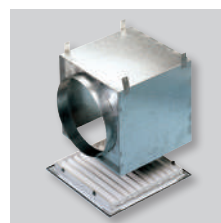

RP
GRI mounting frame.

ELECTRICAL ACCESSORIES



AIRSENS-CO2
AIRSENS-VOC
AIRSENS-RH
IAQ intelligent sensors that incorporates an internal CO₂ or VOC or HR sensor.



CONTROL ECOWATT AC/4A
Control element for demand controlled ventilation system.



REB-ECOWATT
Speed controller for fans fitted with EC motor.



TDP-S
Pressure sensor without display.
TDP-D
Pressure sensor with display.
TDP-PI
Pressure sensor with display.



CPFL-S / CPFL-E
Presence detector.



CONTROL ECOWATT BASIC
Speed control and single-phase ON/OFF.