



Centrifugal roof mounted fans, low profile, horizontal discharge, backward blade impeller, with polyamide body, special weatherproof cowl and galvanized steel plate base. Dynamically balanced motor-roller assembly.

Single-phase motor 230V - 50/60Hz, IP44, Class F (Class B model 190/060), grease ball bearings permanent and thermal protector. Includes IP65 remote terminal box.



**Flame proof terminal box**  
Very accessible terminal box, made of V0 flameproof plastic, containing the capacitor.



**High efficiency, backward centrifugal blade impeller**  
Low consumption and low maintenance.



**Patented design**  
Great performance.

## TECHNICAL CHARACTERISTICS

Before installation check that the product electrical characteristics listed on the data plate label (voltage, power, frequency, etc.) match those of the intended electrical supply.

Model	Speed (r.p.m.)	Maximum absorbed power (W)	Maximum absorbed current at 230V (A)	Maximum air volume (m <sup>3</sup> /h)	Sound pressure level* (dB(A))		Working temperature (°C)	Weight (Kg)	Optional voltage regulator	
					Inlet	Outlet			REB	RMB
TPSB/2-190/060	2520	61	0,3	600	50	53	-40/+70	3,4	REB-1 N	RMB-1,5
TPSB/2-225/088	2670	151	0,6	1.170	56	60	-40/+60	6,4	REB-1 N	RMB-1,5
TPSB/2-250/084	2650	222	1,0	1.500	57	61	-40/+60	6,4	REB-2,5 N	RMB-1,5

\*Sound pressure level, measured at 3 meters, with the roof fan installed on a flat surface, working at points 2 of the characteristic curve.

## DIMENSIONS (mm)

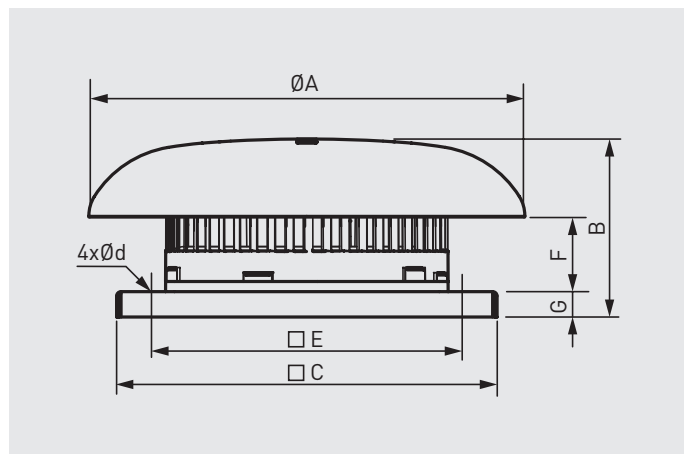

Model	A	B	C	D	E	F	G
TPSB/2-190/060	344	141	300	10	245	59	20
TPSB/2-225/088	452	186	435	10	330	87	20
TPSB/2-250/084	452	182	435	10	330	83	20

## PERFORMANCE CURVES

- $q_v$ : Airflow in  $m^3/h$ .
- $p_{sf}$ : Static pressure in Pa.
- SFP: Specific power factor, in  $W/m^3/s$  (blue curves).
- Dry air at  $20^\circ C$  and  $760$  mmHg.
- Performance data in accordance with ISO 5801 and AMCA 210-99 Standards.

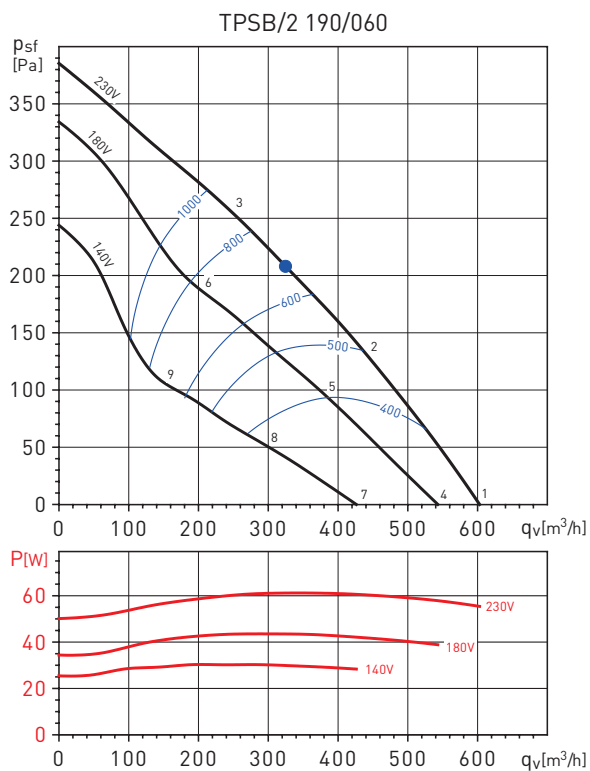

## Power Spectra in dB (A)

Duty point		63	125	250	500	1.000	2.000	4.000	8.000	LwA
1	Inlet	30	41	60	60	67	67	65	51	72
	Outlet	33	43	64	63	69	73	67	54	76
2	Inlet	27	38	58	56	62	63	58	44	67
	Outlet	29	40	60	59	64	68	61	46	71
3	Inlet	32	45	58	59	64	60	53	41	67
	Outlet	32	45	59	60	66	65	55	43	70
4	Inlet	28	39	58	58	65	65	63	49	70
	Outlet	31	41	62	61	67	71	65	52	74
5	Inlet	24	35	55	53	59	60	55	41	64
	Outlet	26	37	57	56	61	65	58	43	67
6	Inlet	28	41	54	55	60	56	49	37	64
	Outlet	28	41	55	56	62	61	51	39	66
7	Inlet	23	34	53	53	60	60	58	44	65
	Outlet	26	36	57	56	62	66	60	47	69
8	Inlet	18	29	49	47	53	54	49	35	58
	Outlet	20	31	51	50	55	59	52	37	61
9	Inlet	22	35	48	49	54	50	43	31	57
	Outlet	22	35	49	50	56	55	45	33	60

## PERFORMANCE CURVES

- $q_v$ : Airflow in  $m^3/h$ .
- $p_{sf}$ : Static pressure in Pa.
- SFP: Specific power factor, in  $W/m^3/s$  (blue curves).
- Dry air at  $20^\circ C$  and  $760$  mmHg.
- Performance data in accordance with ISO 5801 and AMCA 210-99 Standards.

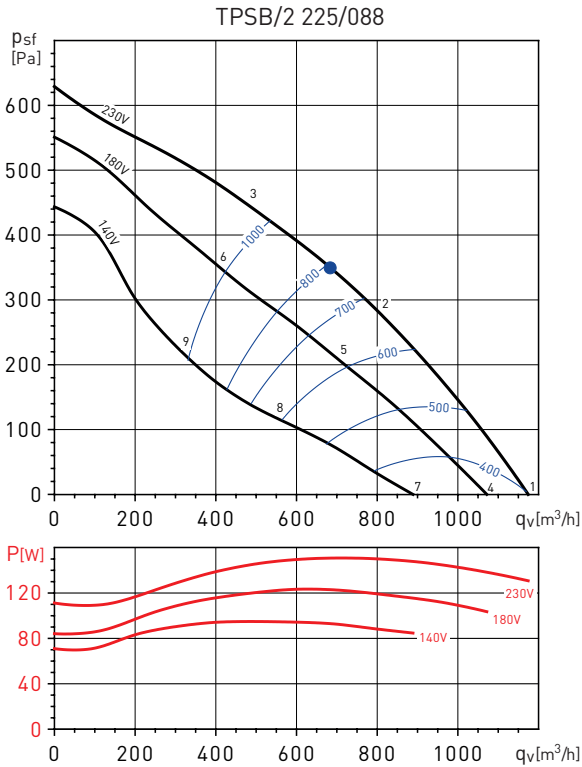

### Power Spectra in dB (A)

Duty point		63	125	250	500	1.000	2.000	4.000	8.000	LwA
1	Inlet	35	46	61	69	74	73	71	51	78
	Outlet	36	47	66	71	78	80	73	67	83
2	Inlet	35	44	58	66	70	66	62	53	73
	Outlet	34	45	63	67	74	74	65	57	78
3	Inlet	44	53	66	70	72	65	59	52	75
	Outlet	45	55	68	72	77	74	65	58	80
4	Inlet	33	44	59	67	72	71	69	49	76
	Outlet	34	45	64	69	76	78	71	65	81
5	Inlet	32	41	55	63	67	63	59	50	70
	Outlet	31	42	60	64	71	71	62	54	75
6	Inlet	41	50	63	67	69	62	56	49	72
	Outlet	42	52	65	69	74	71	62	55	77
7	Inlet	29	40	55	63	68	67	65	45	72
	Outlet	30	41	60	65	72	74	67	61	77
8	Inlet	26	35	49	57	61	57	53	44	64
	Outlet	25	36	54	58	65	65	56	48	69
9	Inlet	36	45	58	62	64	57	51	44	67
	Outlet	37	47	60	64	69	66	57	50	72

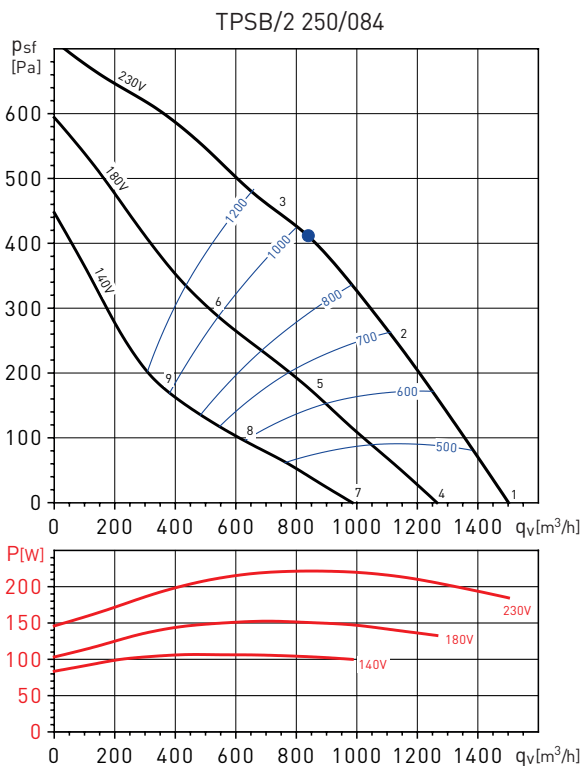

### Power Spectra in dB (A)

Duty point		63	125	250	500	1.000	2.000	4.000	8.000	LwA
1	Inlet	38	49	70	71	75	72	78	63	81
	Outlet	40	50	71	73	80	79	77	66	84
2	Inlet	34	46	66	68	69	68	64	55	74
	Outlet	35	46	66	69	75	74	67	57	79
3	Inlet	42	53	66	70	72	67	60	53	76
	Outlet	45	55	70	73	77	74	64	56	80
4	Inlet	35	46	67	68	72	69	75	60	79
	Outlet	37	47	68	70	77	76	74	63	82
5	Inlet	30	42	62	64	65	64	60	51	71
	Outlet	31	42	62	65	71	70	63	53	75
6	Inlet	37	48	61	65	67	62	55	48	71
	Outlet	40	50	65	68	72	69	59	51	76
7	Inlet	30	41	62	63	67	64	70	55	73
	Outlet	32	42	63	65	72	71	69	58	76
8	Inlet	24	36	56	58	59	58	54	45	64
	Outlet	25	36	56	59	65	64	57	47	69
9	Inlet	31	42	55	59	61	56	49	42	65
	Outlet	34	44	59	62	66	63	53	45	69

## MOUNTING ACCESSORIES- INSTALLATION

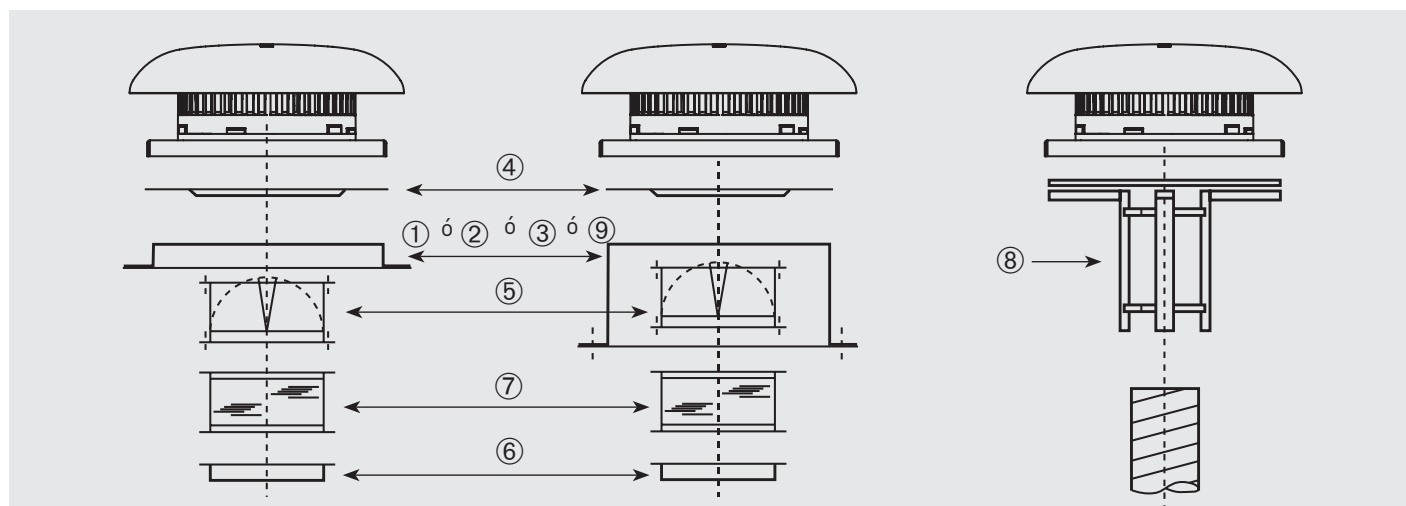

Model type	① Sealing frame	② Flat roof insulated up stand	③ Acoustic up stand	④ Accessory adapter plate	⑤ Backdraft shutter	⑥ Flange with spigot	⑦ Flexible couplig	⑧ Circular adapter	⑨ Support base for inclined curb mounted installations
TPSB/2-190/060	JMS-300	JBS-300	JAA-300	JPA-300	JCA-300	JBR-300	JAE-300	JCC-300	BI-3
TPSB/2-225/088	JMS-435	JBS-435	JAA-435	JPA-435	JCA-435	JBR-435	JAE-435	JCC-435	BI-4
TPSB/2-250/084	JMS-435	JBS-435	JAA-435	JPA-435	JCA-435	JBR-435	JAE-435	JCC-435	BI-4

## MOUNTING ACCESSORIES

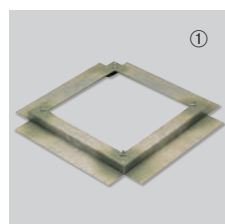

### JMS Sealing frame

- For mounting a roof fan on an up stand or base.
- Supplied with screws and gasket for a complete weatherproof seal.

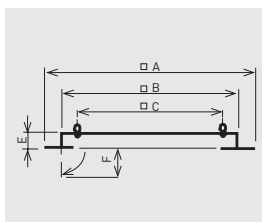

Model	oA	oB	oC	E	F
JMS-300	470	290	245	50	70
JMS-435	600	420	330	50	70

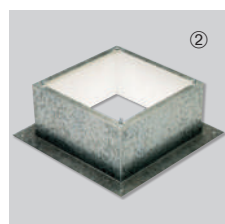

### JBS Flat roof up stand

- For mounting a fan on a Rat roof without up stands.
- For use on horizontal roofs.
- Internal insulation to prevent condensation.
- Supplied with screws and gasket for a complete weather seal.

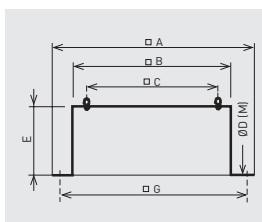

Model	oA	oB	oC	Ø D (M)	E	oG
JBS-300	470	289	245	10,5 (M8)	300	380
JBS-435	600	419	330	11 (M10)	300	510



### JPA Accessory adapter plate

- Used when mounting the accessories (JCA, JBR, JAE).
- Allows the fan to be disconnected from the upstand without having to remove the duct.

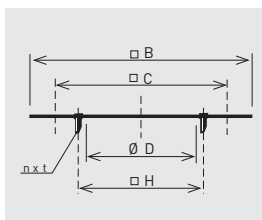

Model	oB	oC	Ø D	next	Ø H
JPA-300	289	245	182	4xM6	205
JPA-435	419	330	252	4xM8	280



### JCA Backdraft shutter

- Prevents backdraft when the fan is not operating.
- To be mounted at the fan inlet with the JPA plate.

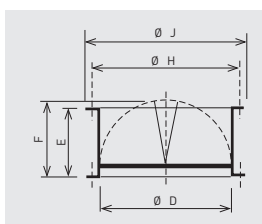

Model	Ø D	E	F	Ø H	Ø J
JCA-300	182	100	124	205	219
JCA-435	252	145	174	280	300

ACCESORIOS DE MONTAJE



**JBR N Flange**

- For use when circular connection is required directly to the fan.
- To be mounted at the fan inlet with the JPA plate or Cxed directly to the fan base (rivets or screws not supplied).

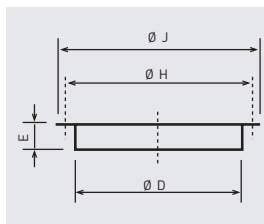

Model	Ø D	E	Ø H	Ø J
JBR-300 N	182	55	205	219
JBR-435 N	252	55	280	300



**JAE N Flexible coupling**

- Reduces the transmission of vibrations when the duct is connected directly to the fan.
- To be mounted at the fan inlet with JPA plate.

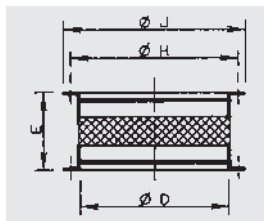

Model	Ø D	E	Ø H	Ø J
JAE-300 N	182	164	205	219
JAE-435 N	252	164	280	300



**JCC Adapter for circular duct**

- For use when fitting the models up to 400, directly to a spirally wound circular duct.

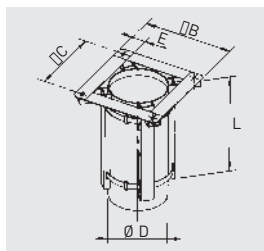

Model	Ø B	Ø C	Ø D	E	L
JCC-300	290	245	180	45	350
JCC-435	390	330	250	60	350



**BI Support base for inclined curb mounted installations**

- To ensure a proper installation of the CRHB-CRHT roof fan it is essential to specify the roof pitch angle and the distance between the roof beam profiles.

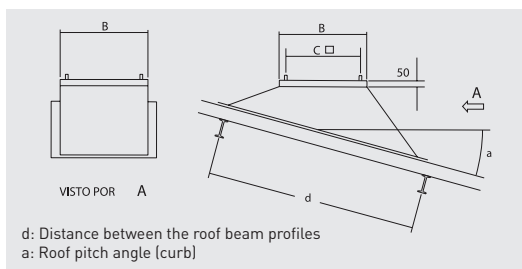

	B	C
BI-3	289	245
BI-4	419	330

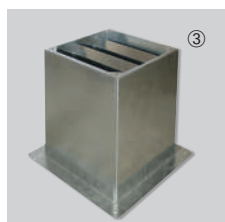

**JAA Acoustic up stand**

- Reduces in duct and radiated noise.
- For use when mounting a fan on a Rat roof without up stands.
- Supplied with screws and gasket for a complete weather seal.

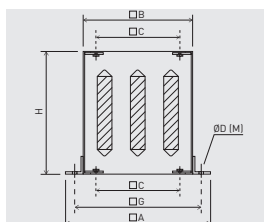

Model	øA	øB	øC	Ø D (M)	H	øG
JAA-300	470	290	245	13 (M10)	750	380
JAA-435	600	419	330	15 (M12)	750	510

Acoustic attenuation in dB (A) per frequency band in Hz.

Model	125	250	500	1000	2000	4000	8000
JAA-300	1	5	13	22	23	16	12
JAA-435	1	7	16	23	25	18	13

**ELECTRICAL ACCESSORIES**



**REB**  
Electronic single phase speed controllers.



**RMB**  
Single phase speed controller by auto-transformer.



**VAPZ**  
Electronic single-phase regulators for single-phase fans 230V-50Hz.



**VRPZ**  
Electronic control with display for single phase 230V-50/60Hz fans.  
Analogical input 0-10V or 4-20mA: The fan works proportionally to the input value with adjustments of the minimum and maximum values of the inputs and outputs.



**SC02-A**  
CO<sub>2</sub> and temperature sensor.

**SC02-AD**  
CO<sub>2</sub> and temperature sensor, with display.

**SCHT-AD**  
CO<sub>2</sub>, temperature and relative humidity sensor with display. .



**CPFL-S / CPFL-E**  
Presence detector.



**TDP-S / TDP-D / TDP-PI**  
Pressure sensor.